

DVD Player

DVP3386K DVP3388K

Service

DVP3386K/93
DVP3388K/98
DVP3388K/96

Service

Service



Service Manual

TABLE OF CONTENTS

	Page
. Technical Specifications.....	1-2
. Safety Instruction, Warning & Notes.....	1-3
. QSG & DFU Instruction.....	2-1
. Mechanical and Dismantling Instructions.....	3-1
. Software Version & Upgrades, Region Code Change.....	4-1
. Trouble Shooting Chart.....	5-1
. Wiring Diagram.....	6-1
. Electrical Diagrams and Print-layouts.....	7-1
. Set Mechanical Exploded view & Part list.....	8-1
. Revision List.....	9-1

©Copyright 2009 Philips Consumer Electronics B.V. Eindhoven, The Netherlands
All rights reserved. No part of this publication may be reproduced, stored in a retrieval system or transmitted, in any form or by any means, electronic, mechanical, photocopying, or otherwise without the prior permission of Philips.

**CLASS 1
LASER PRODUCT**

Specification For DVP3386K/93



Note

- Specification and design are subject to change without notice.

Accessories supplied

- Quick Start Guide
- Remote control and batteries
- Audio/video cables

Playback media

- DVD-Video, Video CD/SVCD, Audio CD, CD-R/CD-RW, DVD+R/+RW, DVD-R/-RW, DivX-CD, Picture CD, MP3-CD, WMA-CD, WMV-CD, USB flash drive

USB

- Compatibility: Hi-Speed USB (2.0)
- Class support: UMS (USB Mass Storage Class)

TV standard

- Number of lines:
 - 625 (PAL/50Hz); 525 (NTSC/60Hz)
- Playback: Multi-standard (PAL/NTSC)

Video performance

- Video DAC: 12 bits, 108 MHz
- Y Pb Pr: 0.7 V_{pp} ~ 75 ohm
- Video output: 1 V_{pp} ~ 75 ohm

Video format

- Digital compression:
 - MPEG 2: DVD/SVCD
 - MPEG 1: VCD/DivX
- Horizontal resolution:
 - DVD: 720/1920 pixels (50 Hz); 720/1920 pixels (60 Hz)
 - VCD: 352 pixels (50 Hz); 352 pixels (60 Hz)
- Vertical resolution:
 - DVD: 576/1080 lines (50 Hz); 480/1080 lines (60 Hz)
 - VCD: 288 lines (50 Hz); 240 lines (60 Hz)

Audio performance

- DA converter: 24 bits, 192 kHz
- Frequency response:
 - DVD: 4 Hz - 22 kHz (48 kHz); 4 Hz - 44 kHz (96 kHz)
 - SVCD: 4 Hz - 20 kHz (44.1 kHz); 4 Hz - 22 kHz (48 kHz)
 - CD/VCD: 4 Hz - 20 kHz (44.1 kHz)
- Signal-Noise (1 kHz): > 90 dB (A-weighted)
- Dynamic range (1 kHz): > 80 dB (A-weighted)
- Crosstalk (1 kHz): > 70 dB
- Distortion/noise (1 kHz): > 65 dB
- MPEG MP3: MPEG Audio L3

Audio format

- Digital:
 - MPEG/AC-3/PCM: Compressed digital (16, 20, 24 bits fs, 44.1, 48, 96 kHz)
 - MP3 (ISO 9660): 96, 112, 128, 256 kbps & variable bit rate fs, 32, 44.1, 48 kHz
- Analog sound stereo
- Dolby surround compatible downmix from Dolby Digital multi-channel sound

Connections

- Y Pb Pr output: Cinch 3x
- Video output: Cinch (yellow)
- Audio output (Front L+R): Cinch (white/red)
- Digital output:
 - 1 coaxial: IEC60958 for CDDA/LPCM; IEC61937 for MPEG 1/2, Dolby Digital
 - 1 optical
- HDMI output
- 5.1 channel analog output
 - Audio Front L+R: Cinch (white/red)
 - Audio Rear L+R: Cinch (white/red)
 - Audio Center: Cinch (blue)
 - Audio Subwoofer: Cinch (black)

Specification

For DVP3388K/98 & DVP3388K/96



Note

- Specification and design are subject to change without notice.

Accessories supplied

- Quick Start Guide
- Remote control and batteries
- Audio/video cables
- Power cable (except for Taiwan)

Playback media

- DVD-Video, Video CD/SVCD, Audio CD, CD-R/CD-RW, DVD+R/+RW, DVD-R/-RW, DivX-CD, Picture CD, MP3-CD, WMA-CD, WMV-CD, USB flash drive

USB

- Compatibility: Hi-Speed USB (2.0)
- Class support: UMS (USB Mass Storage Class)

TV standard

- Number of lines:
 - 625 (PAL/50Hz); 525 (NTSC/60Hz)
- Playback: Multi-standard (PAL/NTSC)

Video performance

- Video DAC: 12 bits, 108 MHz
- Y Pb Pr: 0.7 V_{pp} ~ 75 ohm
- Video output: 1 V_{pp} ~ 75 ohm

Video format

- Digital compression:
 - MPEG 2: DVD/SVCD
 - MPEG 1: VCD/DivX
- Horizontal resolution:
 - DVD: 720/1920 pixels (50 Hz); 720/1920 pixels (60 Hz)
 - VCD: 352 pixels (50 Hz); 352 pixels (60 Hz)
- Vertical resolution:
 - DVD: 576/1080 lines (50 Hz); 480/1080 lines (60 Hz)
 - VCD: 288 lines (50 Hz); 240 lines (60 Hz)

Audio performance

- DA converter: 24 bits, 192 kHz
- Frequency response:
 - DVD: 4 Hz - 22 kHz (48 kHz); 4 Hz - 44 kHz (96 kHz)
 - SVCD: 4 Hz - 20 kHz (44.1 kHz); 4 Hz - 22 kHz (48 kHz)
 - CD/VCD: 4 Hz - 20 kHz (44.1 kHz)
- Signal-Noise (1 kHz): > 90 dB (A-weighted)
- Dynamic range (1 kHz): > 80 dB (A-weighted)
- Crosstalk (1 kHz): > 70 dB
- Distortion/noise (1 kHz): > 65 dB
- MPEG MP3: MPEG Audio L3

Audio format

- Digital:
 - MPEG/AC-3/PCM: Compressed digital (16, 20, 24 bits fs, 44.1, 48, 96 kHz)
 - MP3 (ISO 9660): 96, 112, 128, 256 kbps & variable bit rate fs, 32, 44.1, 48 kHz
- Analog sound stereo
- Dolby surround compatible downmix from Dolby Digital multi-channel sound

Connections

- Y Pb Pr output: Cinch 3x
- Video output: Cinch (yellow)
- Audio output (Front L+R): Cinch (white/red)
- Digital output:
 - 1 coaxial: IEC60958 for CDDA/LPCM; IEC61937 for MPEG 1/2, Dolby Digital
 - 1 optical
- HDMI output
- 5.1 channel analog output
 - Audio Front L+R: Cinch (white/red)
 - Audio Rear L+R: Cinch (white/red)
 - Audio Center: Cinch (blue)
 - Audio Subwoofer: Cinch (black)

Safety instruction, Warning & Notes

Safety instruction

1. General safety

Safety regulations require that during a repair:

- . Connect the unit to the mains via an isolation transformer.
- . Replace safety components indicated by the symbol , only by components identical to the original ones. Any other component substitution (other than original type) may increase risk of fire or electrical shock hazard.

Safety regulations require that after a repair, you must return the unit in its original condition. Pay, in particular, attention to the following points:

- . Route the wires/cables correctly, and fix them with the mounted cable clamps.
- . Check the insulation of the mains lead for external damage.
- . Check the electrical DC resistance between the mains plug and the secondary side:
 - 1) Unplug the mains cord, and connect a wire between the two pins of the mains plug.
 - 2) Set the mains switch the "on" position (keep the mains cord unplug).
 - 3) Measure the resistance value between the mains plug and the front panel, controls, and chassis bottom.
 - 4) Repair or correct unit when the resistance measurement is less than 1M Ω .
 - 5) Verify this, before you return the unit to the customer/user (ref. UL-standard no. 1492).
 - 6) Switch the unit "off", and remove the wire between the two pins of the mains plug.

2.Laser safety

This unit employs a laser. Only qualified service personnel may remove the cover, or attempt to service this device (due to possible eye injury).

Laser device unit

Type	: Semiconductor laser GaAlAs
Wavelength	: 650nm (DVD)
	: 780nm (VCD/CD)
Output power	: 7mW (DVD)
	: 10mW (DVD /CD)

Beam divergence: 60 degree

Note: Use of controls or adjustments or performance of procedure other than those specified herein, may result in hazardous radiation exposure. Avoid direct exposure to beam.

Warning

1. General

. All ICs and many other semiconductors are susceptible to electrostatic discharges (ESD). Careless handling during repair can reduce life drastically. Make sure that, during repair, you are at the same potential as the mass of the set by a wristband with resistance. Keep components and tools at this same potential. Available ESD protection equipment:

1) Complete kit ESD3 (small tablemat, wristband, connection box, extension cable and earth cable)
4822 310 10671.

2) Wristband tester 4822 344 13999.

. Be careful during measurements in the live voltage section. The primary side of the power supply, including the heat sink, carries live mains voltage when you connect the player to the mains (even when the player is "off"!). It is possible to touch copper tracks and/or components in this unshielded primary area, when you service the player. Service personnel must take precautions to prevent touching this area or components in this area. A "lighting stroke" and a stripe-marked printing on the printed wiring board, indicate the primary side of the power supply.

. Never replace modules, or components, while the unit is "on".

2. Laser

. The use of optical instruments with this product, will increase eye hazard.

. Only qualified service personnel may remove the cover or attempt to service this device, due to possible eye injury.

. Repair handling should take place as much as possible with a disc loaded inside the player.

. Text below is placed inside the unit, on the laser cover shield:

**CAUTION: VISIBLE AND INVISIBLE LASER
RADIATION WHEN OPEN, AVOID EXPOSURE
TO BEAM.**

Notes: Manufactured under licence from Dolby Laboratories. The double-D symbol is trademarks of Dolby Laboratories, Inc. All rights reserved.

Notes

Lead-Free requirement for service

IDENTIFICATION:

Regardless of special logo (not always indicated) 

One must treat all sets from 1.1.2005 onwards, according next rules.

Important note: In fact also products a little older can also be treated in this way as long as you avoid mixing solder-alloys (leaded/ lead-free). So best to always use SAC305 and the higher temperatures belong to this.

Due to lead-free technology some rules have to be respected by the workshop during a repair:

- Use only lead-free solder alloy Philips SAC305 with order code 0622 149 00106. If lead-free solder-paste is required, please contact the manufacturer of your solder-equipment. In general use of solder-paste within workshops should be avoided because paste is not easy to store and to handle.
 - Use only adequate solder tools applicable for lead-free solder alloy. The solder tool must be able
 - To reach at least a solder-temperature of 400°C,
 - To stabilize the adjusted temperature at the solder-tip
 - To exchange solder-tips for different applications.
 - Adjust your solder tool so that a temperature around 360°C – 380°C is reached and stabilized at the solder joint. Heating-time of the solder-joint should not exceed ~ 4 sec. Avoid temperatures above 400°C otherwise wear-out of tips will rise drastically and flux-fluid will be destroyed. To avoid wear-out of tips switch off un-used equipment, or reduce heat.
 - Mix of lead-free solder alloy / parts with leaded solder alloy / parts is possible but PHILIPS recommends strongly to avoid mixed solder alloy types (leaded and lead-free). If one cannot avoid, clean carefully the solder-joint from old solder alloy and re-solder with new solder alloy (SAC305).
- Use only original spare-parts listed in the Service-Manuals. Not listed standard-material (commodities) has to be purchased at external companies.
 - Special information for BGA-ICs:
 - always use the 12nc-recognizable soldering temperature profile of the specific BGA (for de-soldering always use highest lead-free temperature profile, in case of doubt)
 - lead free BGA-ICs will be delivered in so-called 'dry-packaging' (sealed pack including a silica gel pack) to protect the IC against moisture. After opening, dependent of MSL-level seen on indicator-label in the bag, the BGA-IC possibly still has to be baked dry. This will be communicated via AYS-website.
Do not re-use BGAs at all.
 - For sets produced before 1.1.2005, containing leaded soldering-tin and components, all needed spare-parts will be available till the end of the service-period. For repair of such sets nothing changes.
 - On our website:
 - www.atyourservice.ce.Philips.com**

You find more information to:

BGA-de-/soldering (+ baking instructions)

Heating-profiles of BGAs and other ICs used in Philips-sets

You will find this and more technical information within the "magazine", chapter "workshop news".

For additional questions please contact your local repair-helpdesk.

Register your product and get support at www.philips.com/welcome

DVP3386K

3

The following excerpt of the Quick Start Guide serves as an introduction to the set. The complete Direction For Use can be download in different languages from Philips Customer Contact & Support site: www.p4c.philips.com

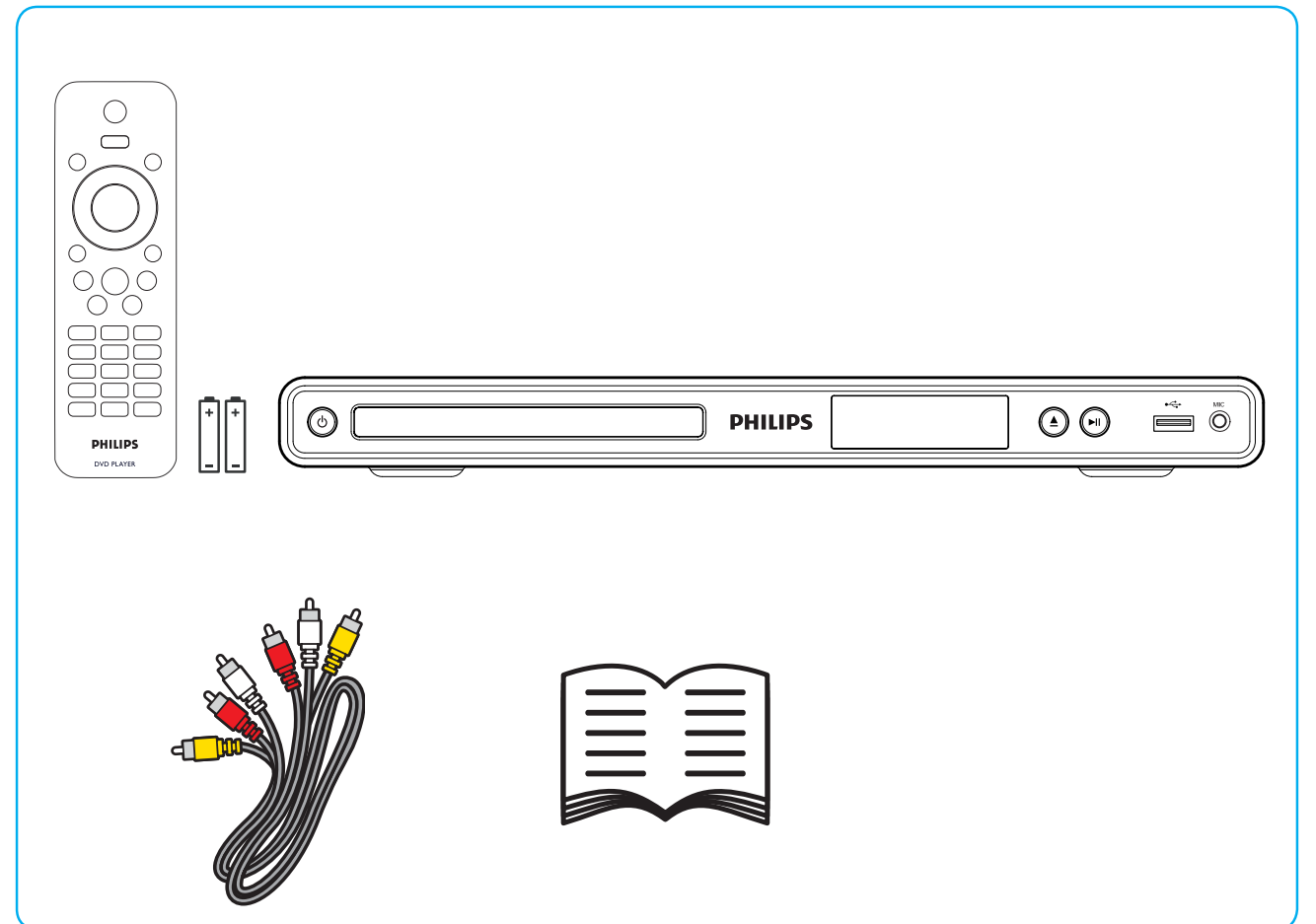
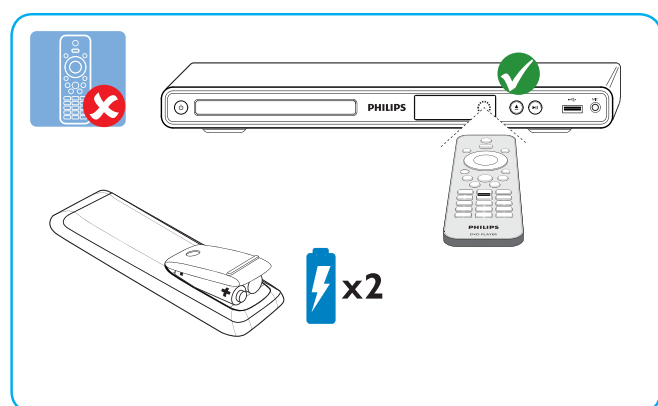
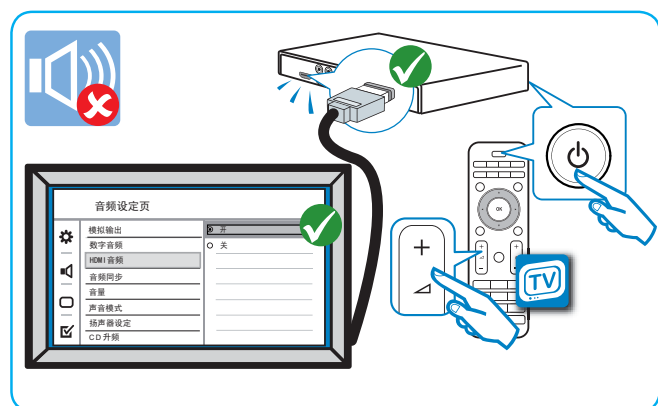
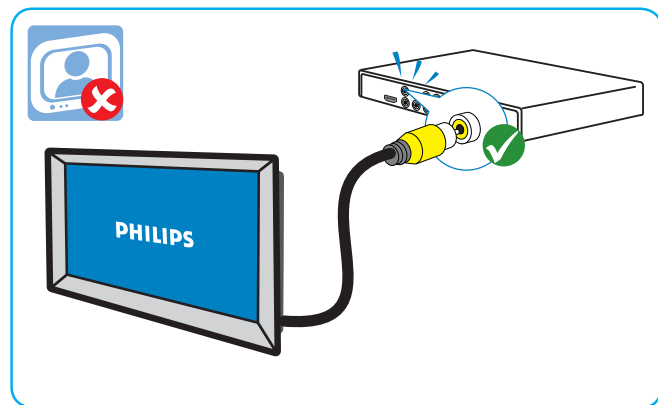
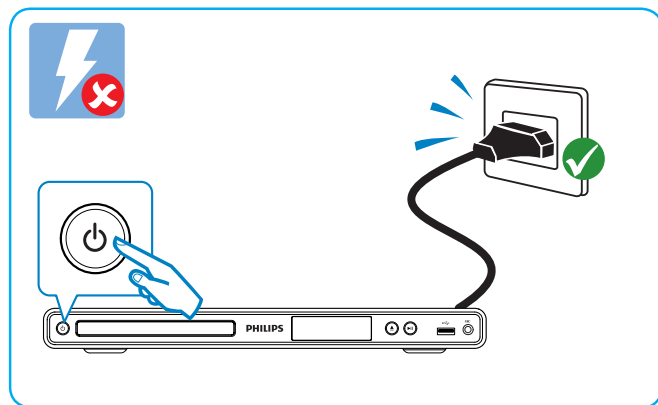
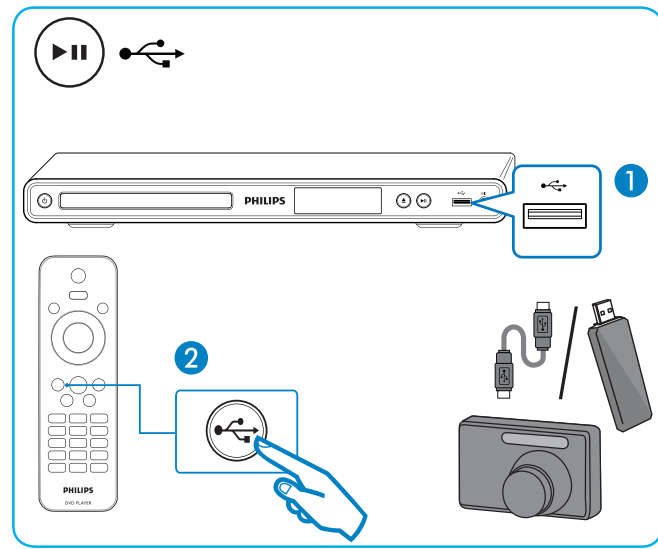
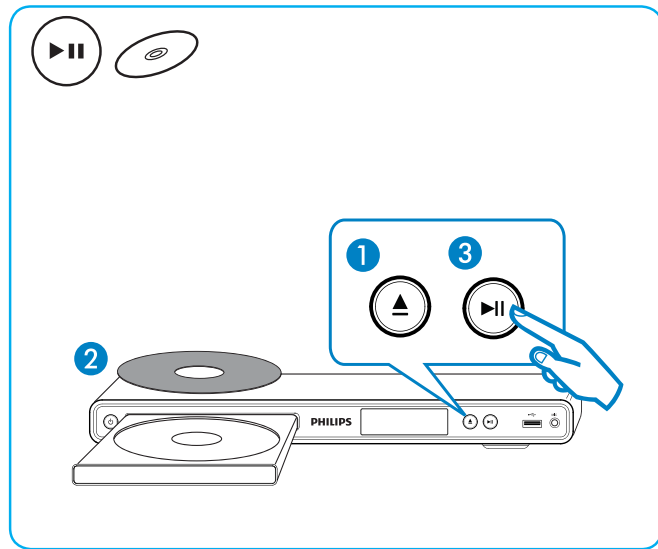

Register your product and get support at www.philips.com/welcome

DVP3388K

3

The following excerpt of the Quick Start Guide serves as an introduction to the set. The complete Direction For Use can be downloaded in different languages from Philips Customer Contact & Support site: www.p4c.philips.com

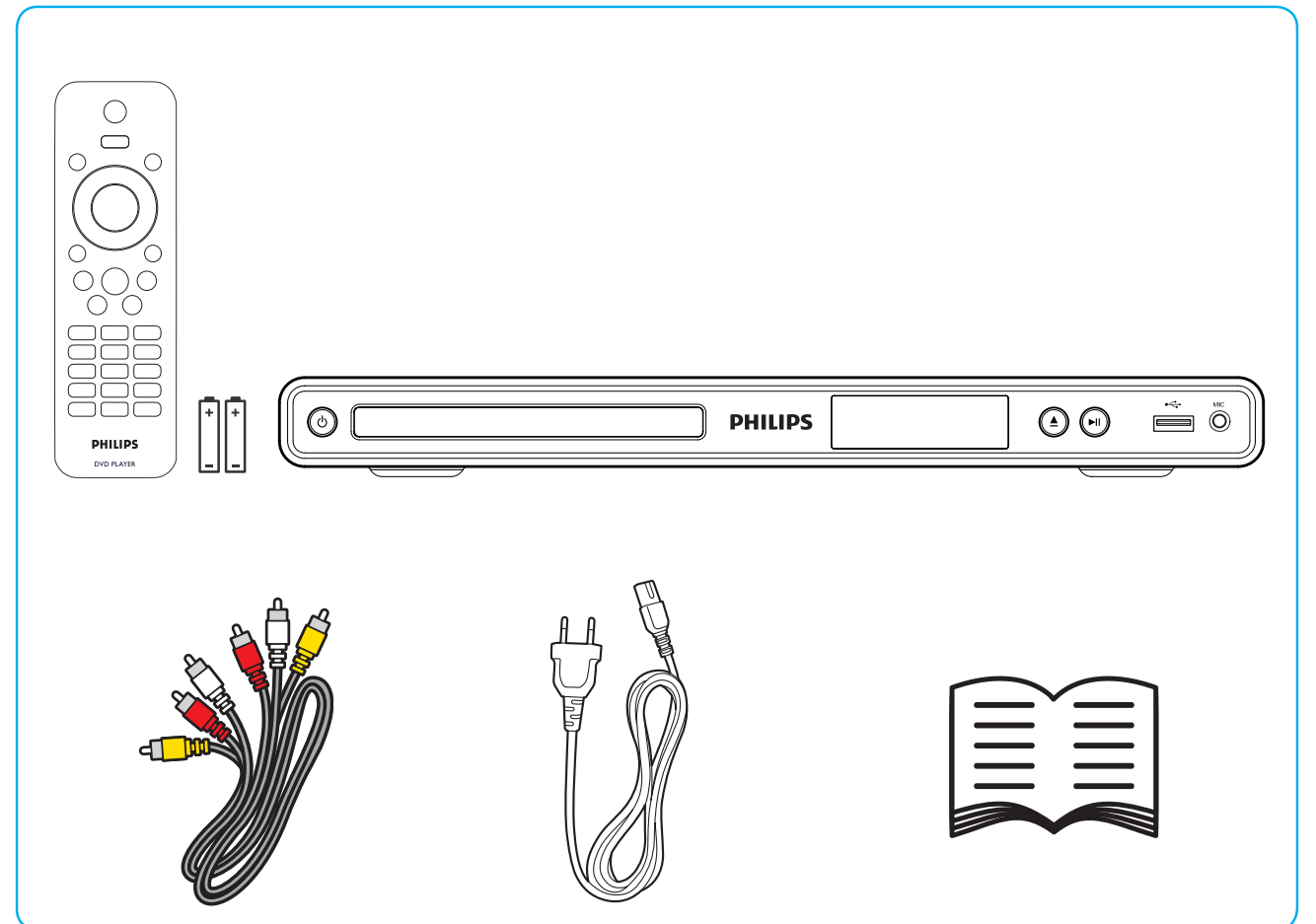
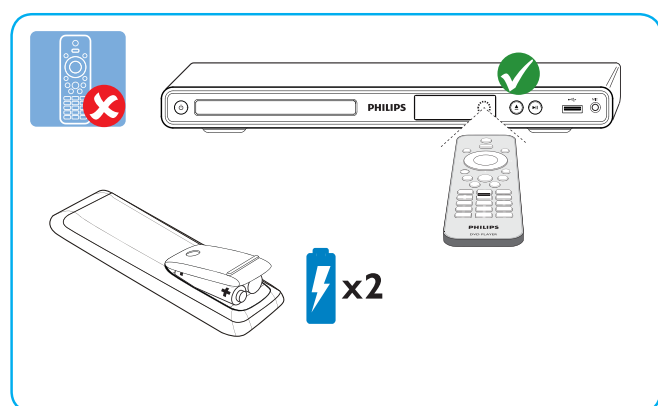
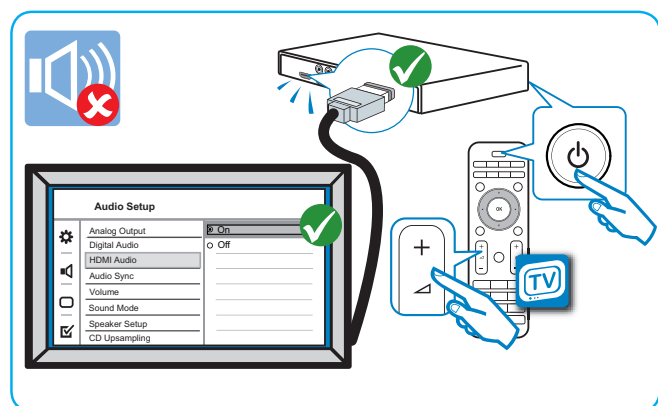
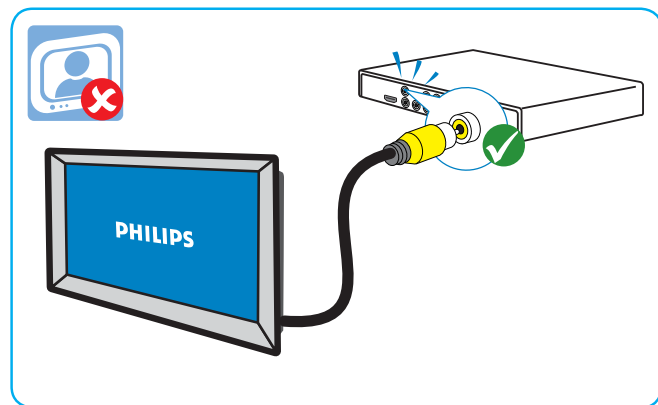
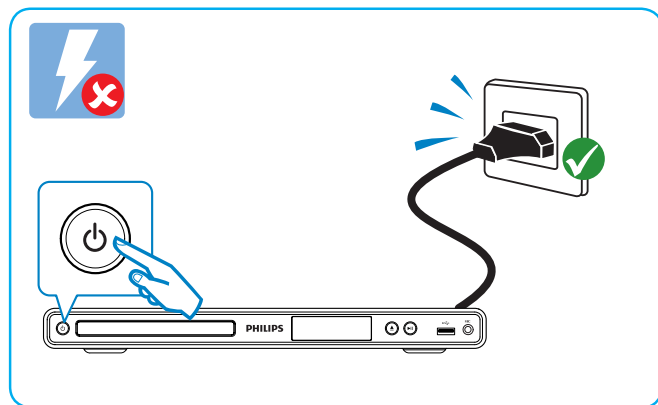
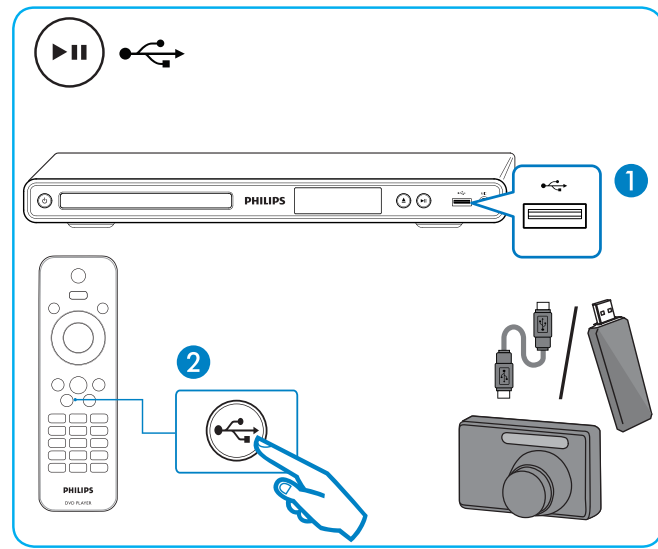
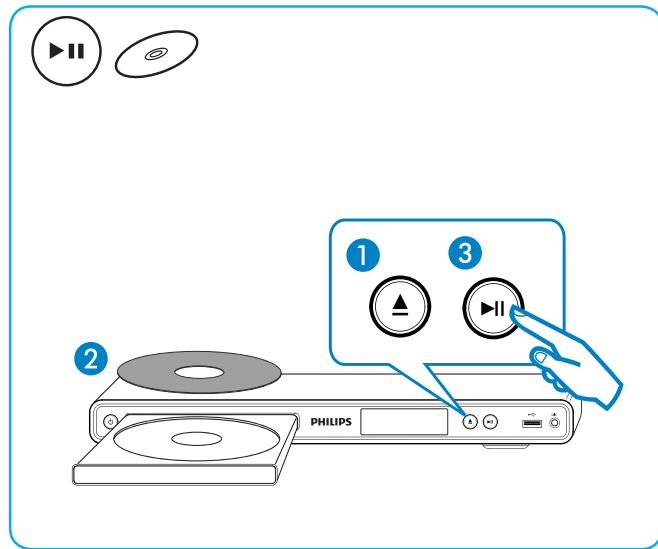

Register your product and get support at www.philips.com/welcome

DVP3388K

3

The following excerpt of the Quick Start Guide serves as an introduction to the set. The complete Direction For Use can be download in different languages from Philips Customer Contact & Support site: www.p4c.philips.com

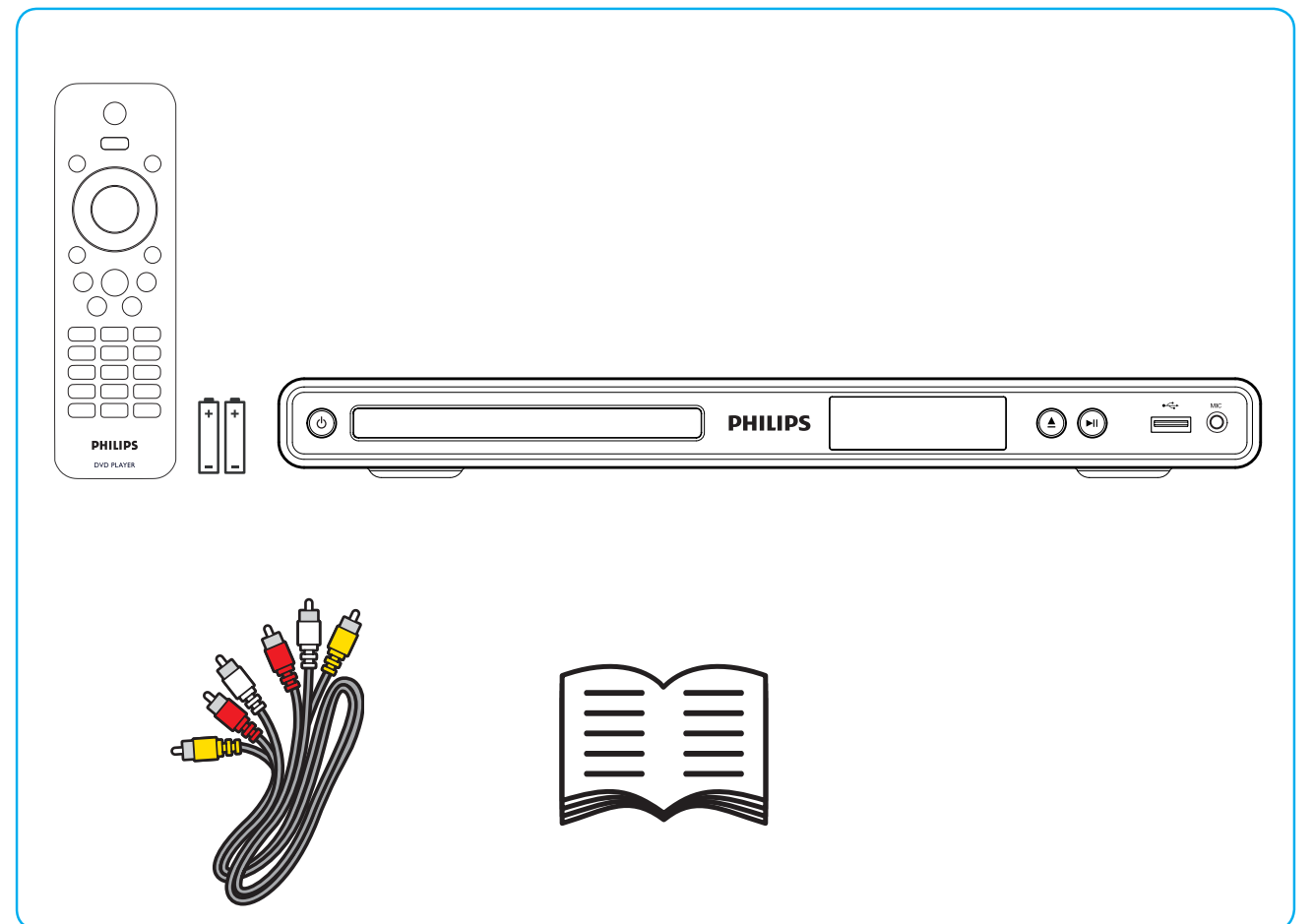
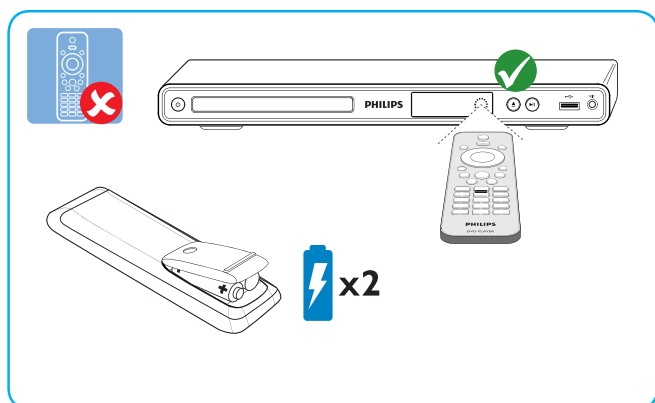
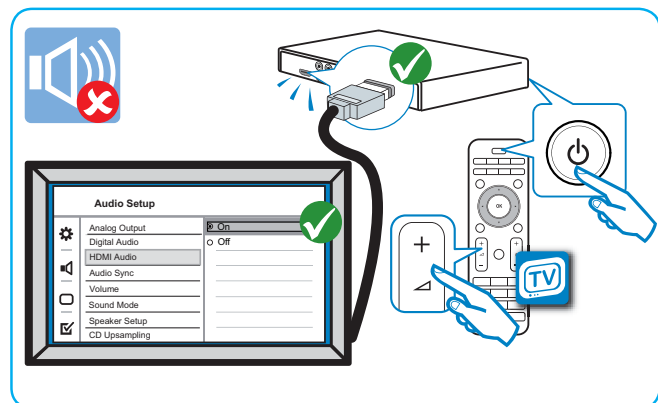
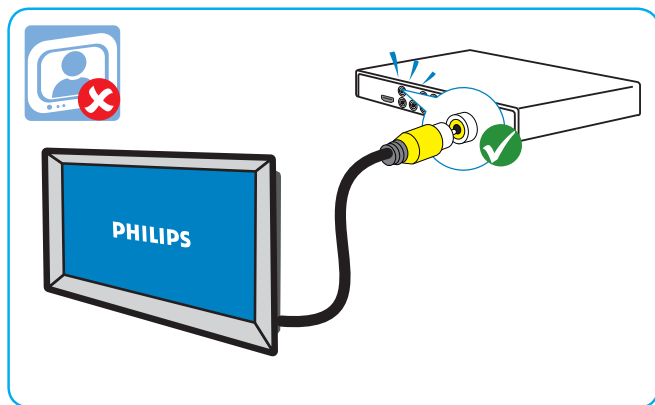
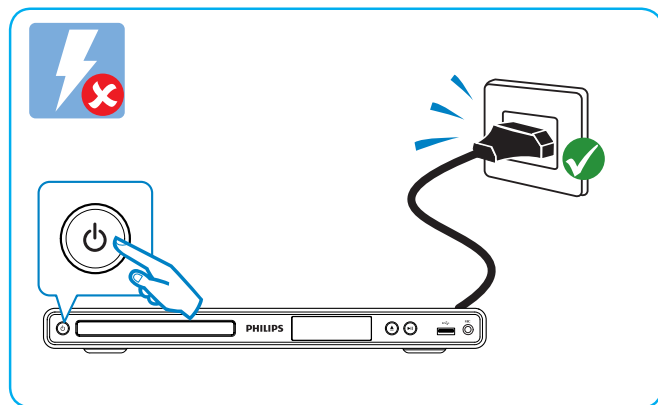
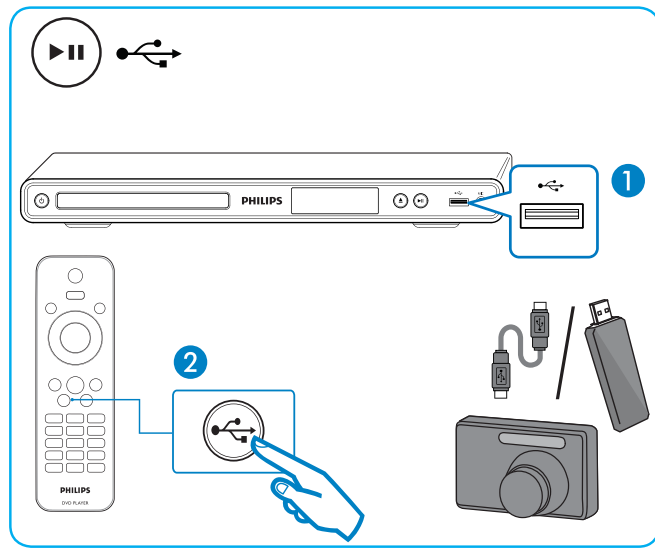
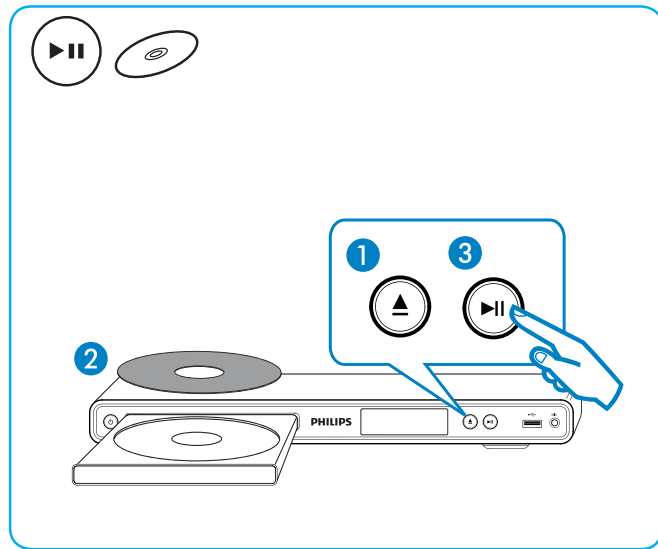

1

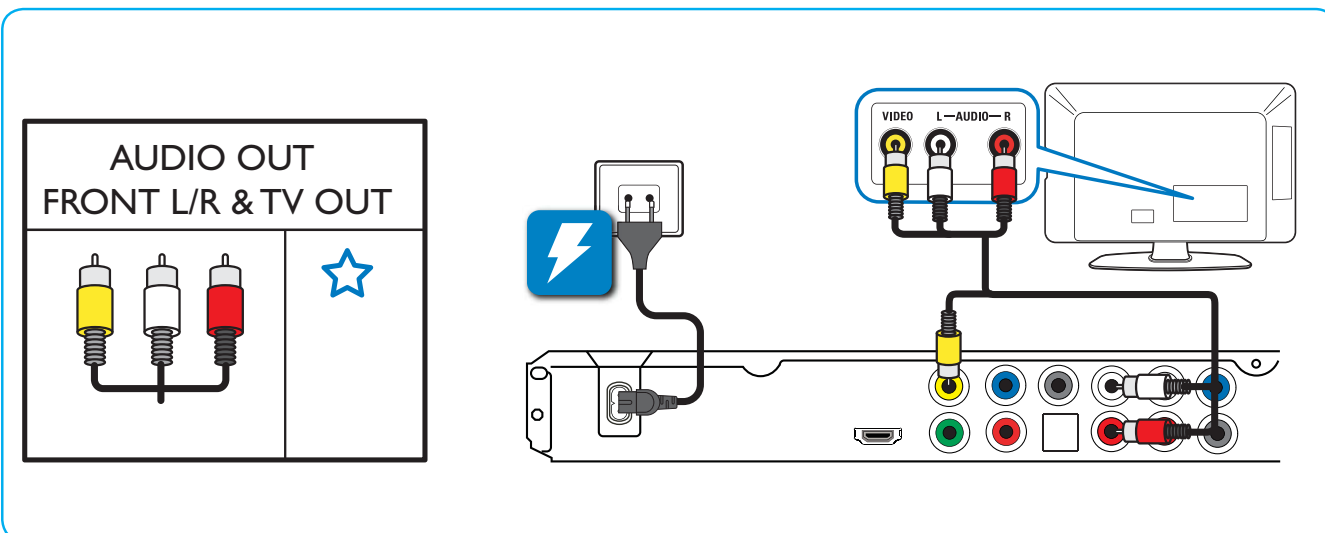
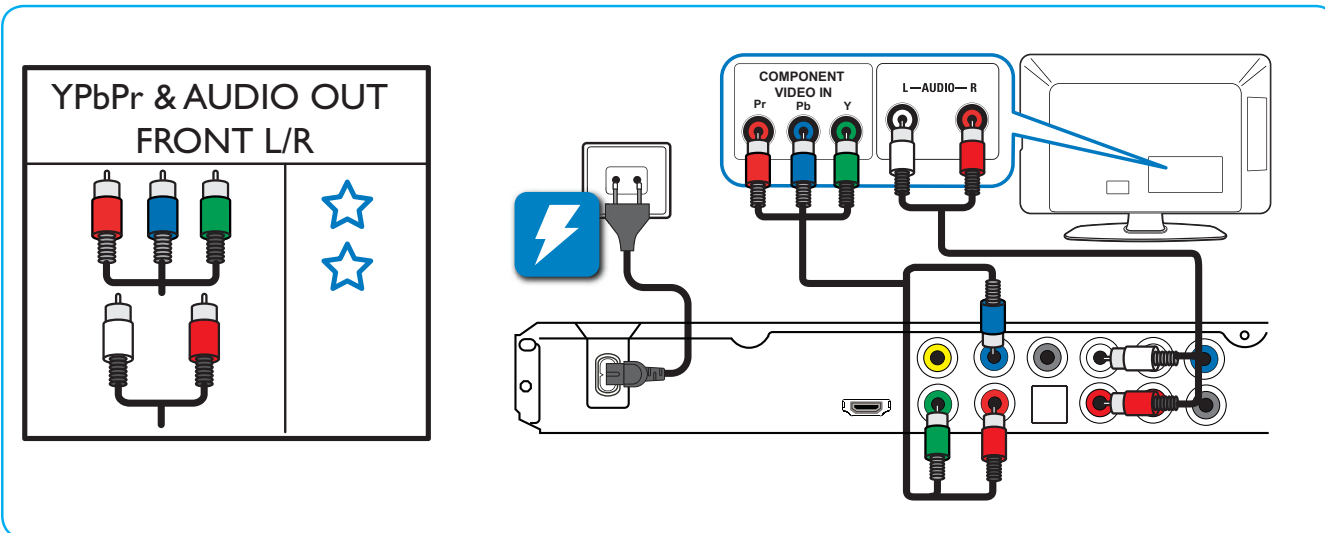
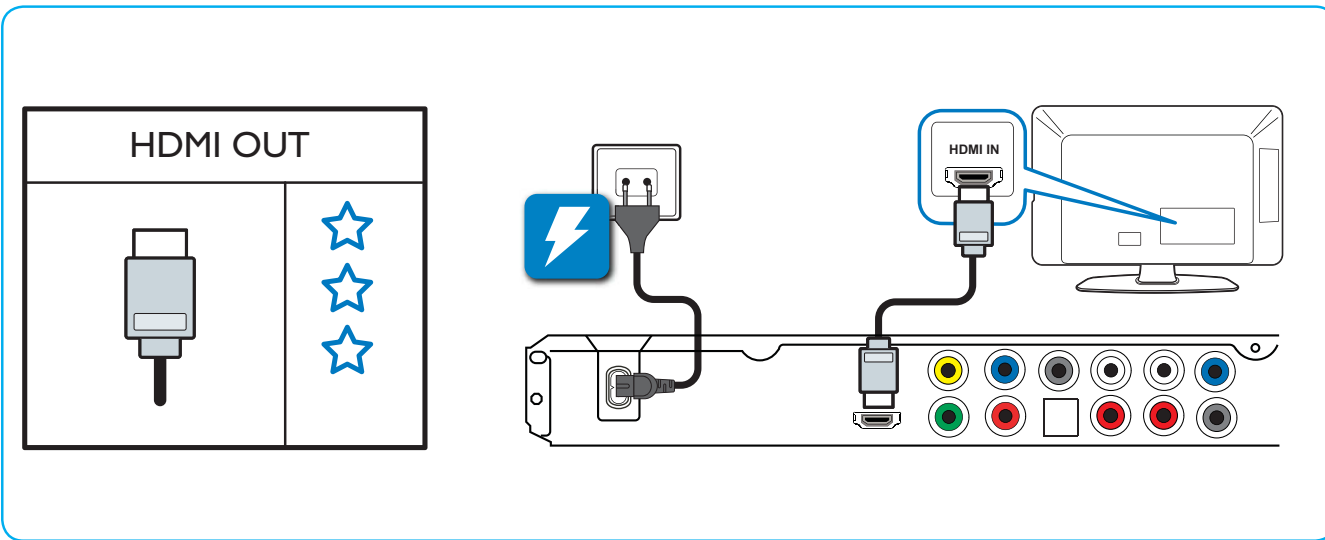

2

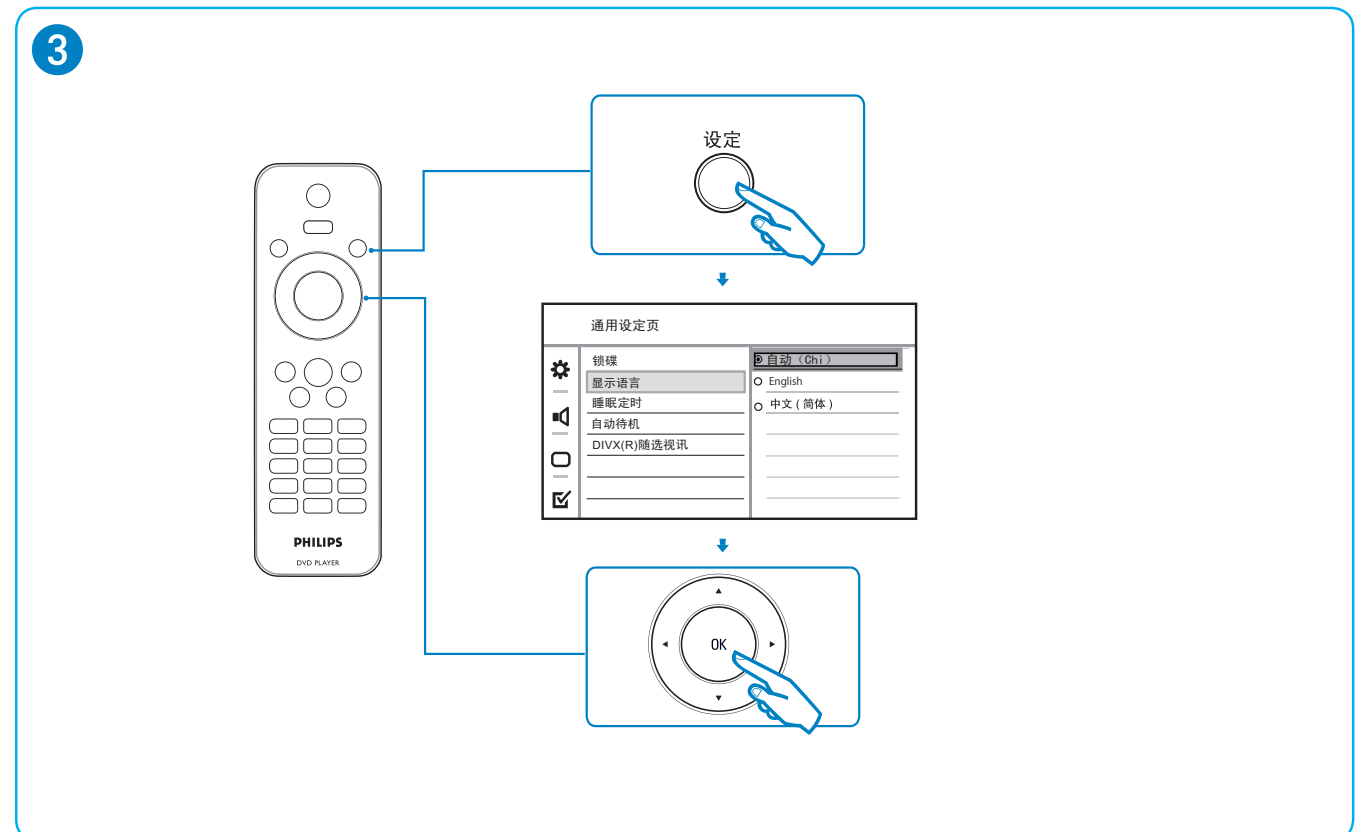
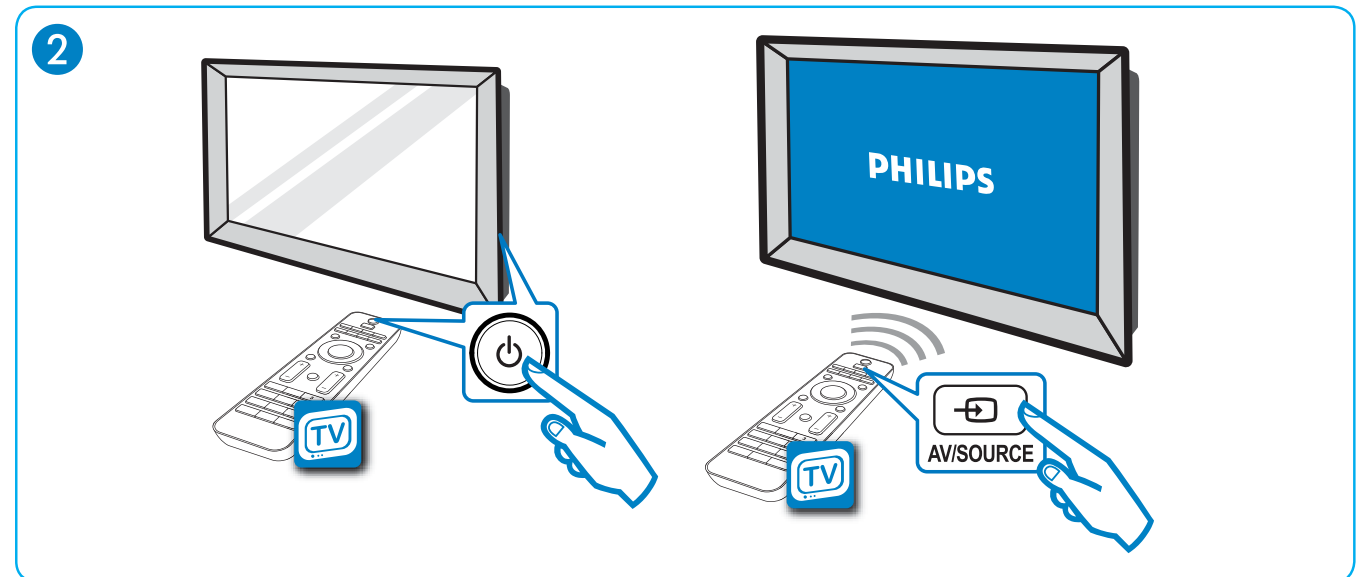
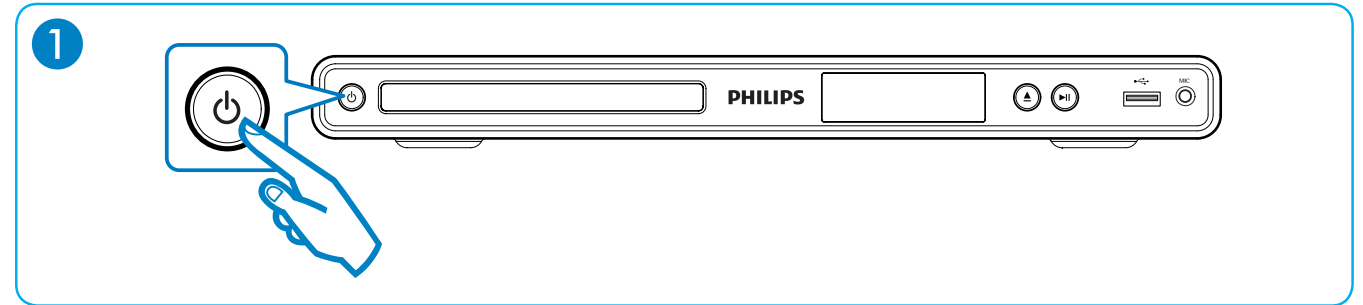

Product overview

Main unit

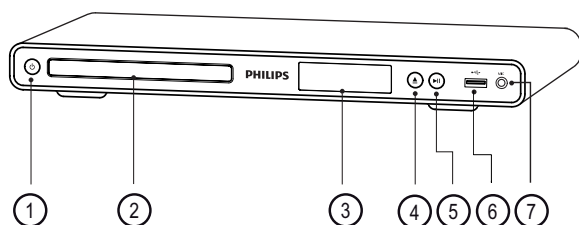

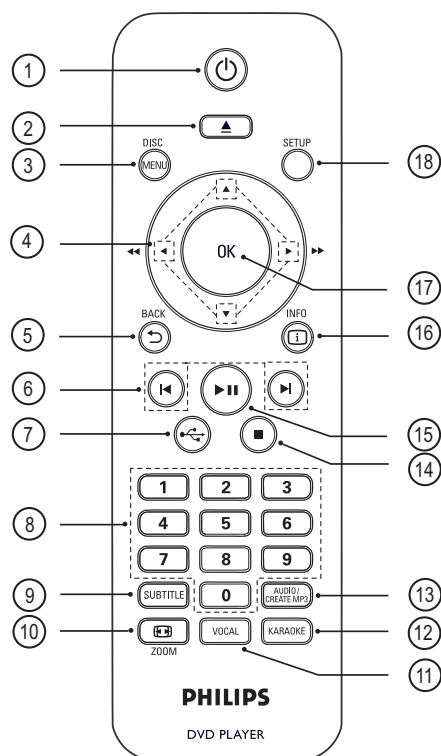

- ① (Standby-on)
 - Turn on the DVD player or switch to standby mode.
- ② **Disc compartment**
- ③ **Display panel**
- ④ (Open/Close)
 - Open or close the disc compartment.
- ⑤ (Play/Pause)
 - Start, pause or resume disc play.
- ⑥ (USB) jack
 - Connect a USB flash drive.
- ⑦ **MIC**
 - Audio input from a microphone.

Remote control



- ① (Standby-On)
 - Turn on the DVD player or switch to standby mode.
 - Press and hold to turn off the DVD player and all HDMI CEC compliant devices.
- ② (Open/Close)
 - Open or close the disc compartment.
- ③ **DISC MENU**
 - Access or exit the disc menu.
 - Switch to disc mode.
 - For VCD/SVCD, turn PBC (Playback Control) on or off in PBC mode.

- ④ ▲▼◀▶ (Navigation buttons)
- Navigate through the menus.
 - Search fast-forward (▶) or fast-backward (◀). Press repeatedly to change the search speed.
 - Search slow-forward (▲) or slow-backward (▼). Press repeatedly to change the search speed.
- ⑤ ↶ **BACK**
- Return to the previous display menu.
 - For DVD, navigate to the title menu.
 - For VCD version 2.0 or SVCD with PBC turned on, return to the menu.
- ⑥ ◀/▶ (Previous/Next)
- Skip to the previous or next title, chapter, or track.
 - Press and hold for fast-backward or fast-forward search.
- ⑦  (USB)
- Switch to USB mode and display the content.
- ⑧ **Numeric buttons**
- Select an item to play.
- ⑨ **SUBTITLE**
- Select DVD or DivX subtitle language.
 - Access the menu to USB copy or USB delete.
- ⑩  **ZOOM**
- Fit the picture format to the TV screen.
 - Zoom in or out of the picture.
- ⑪ **VOCAL**
- Change the audio channel of a karaoke disc.
- ⑫ **KARAOKE**
- Access or exit the karaoke menu.
- ⑬ **AUDIO/CREATE MP3**
- Select an audio language/channel.
 - Access the menu to create MP3.
- ⑭ ■ (Stop)
- Stop disc play.
- ⑮ ▶|| (Play/Pause)
- Start, pause or resume disc play.
- ⑯  **INFO**
- For disc, display the current status or disc information.
 - For slideshows, display a thumbnail view of photo files.
- ⑰ **OK**
- Confirm an entry or selection.
- ⑱ **SETUP**
- Access or exit the setup menu.

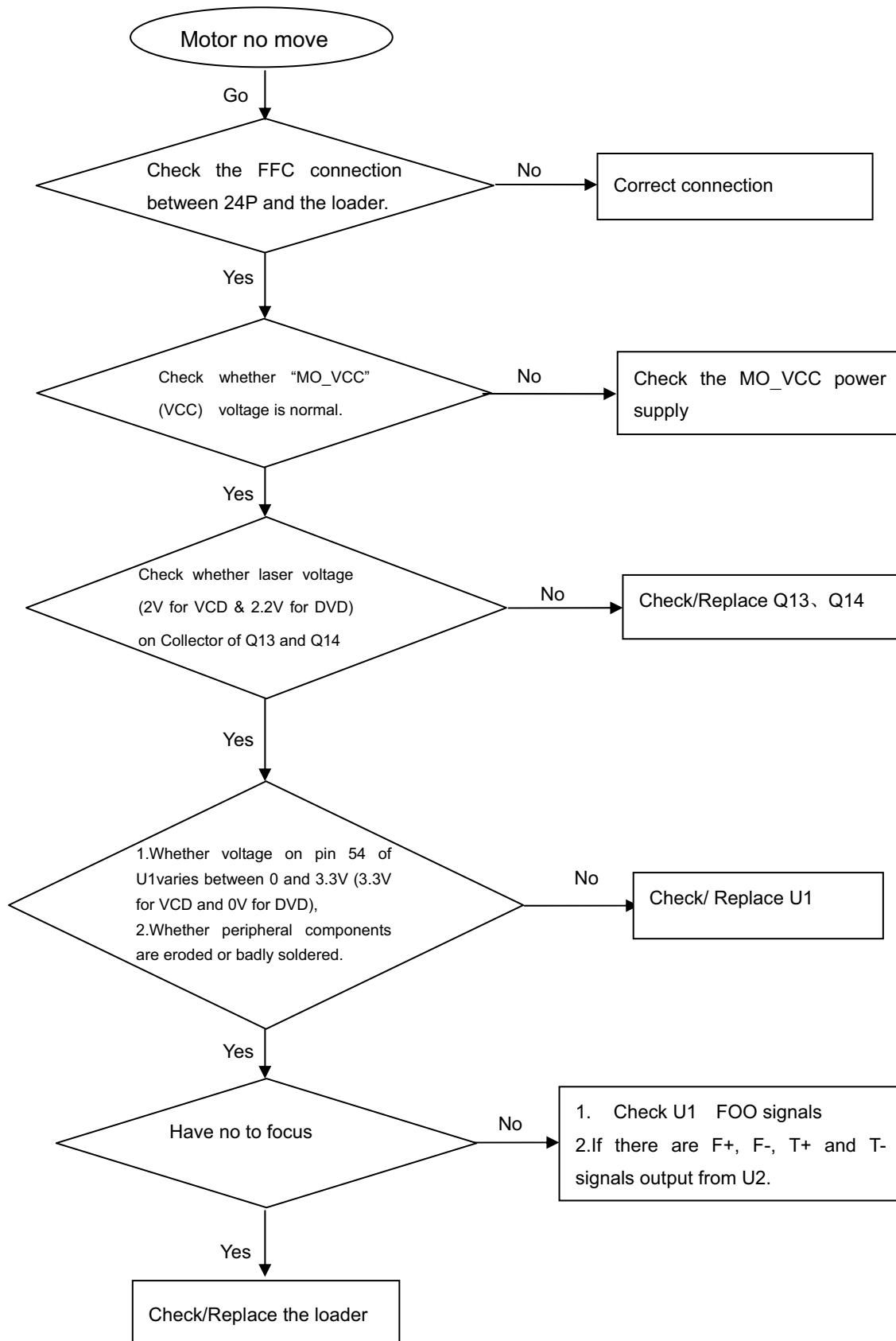
Spindle motor does not move

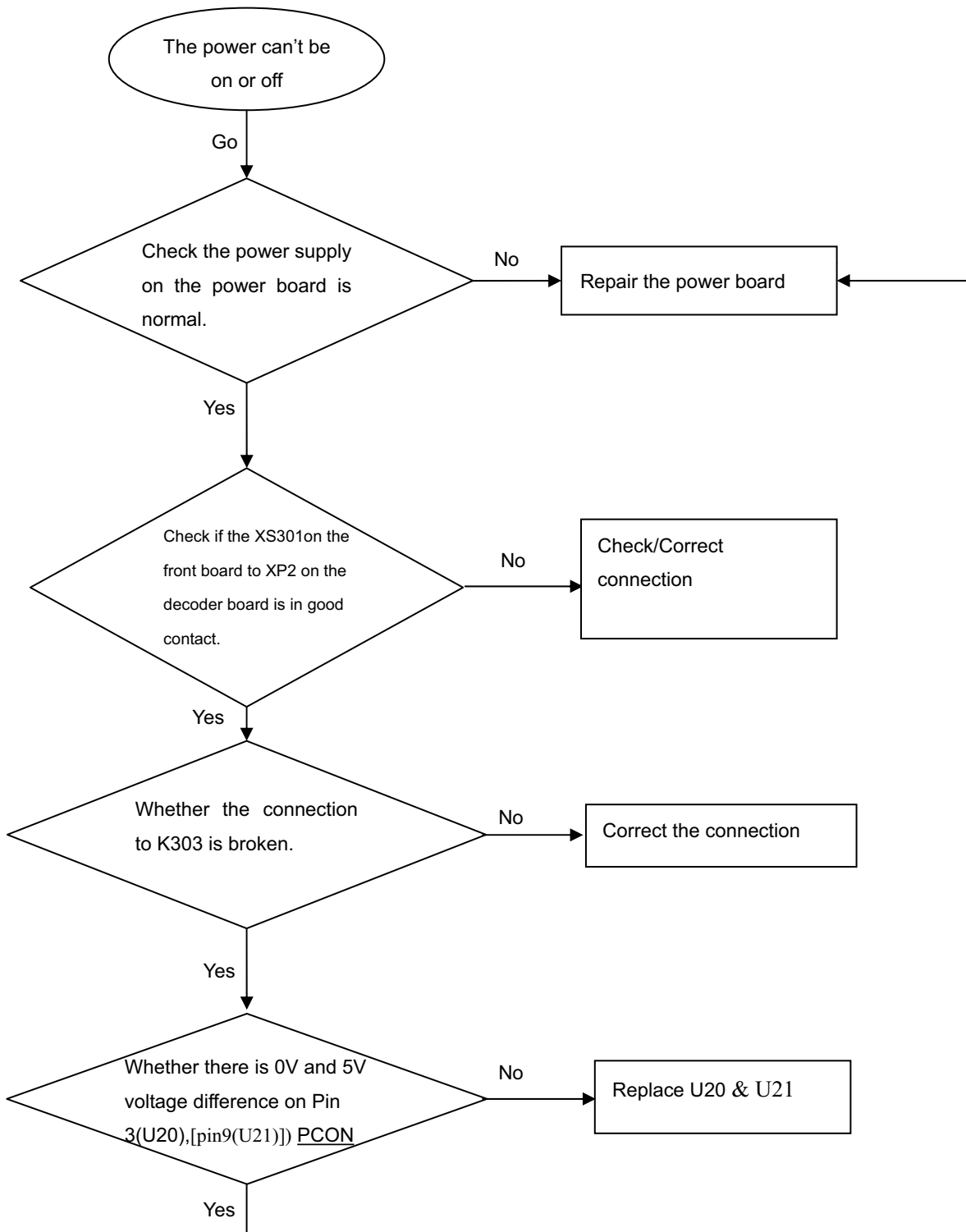
The power can not be on or off

All output voltages on the power board is 0V or deviated.

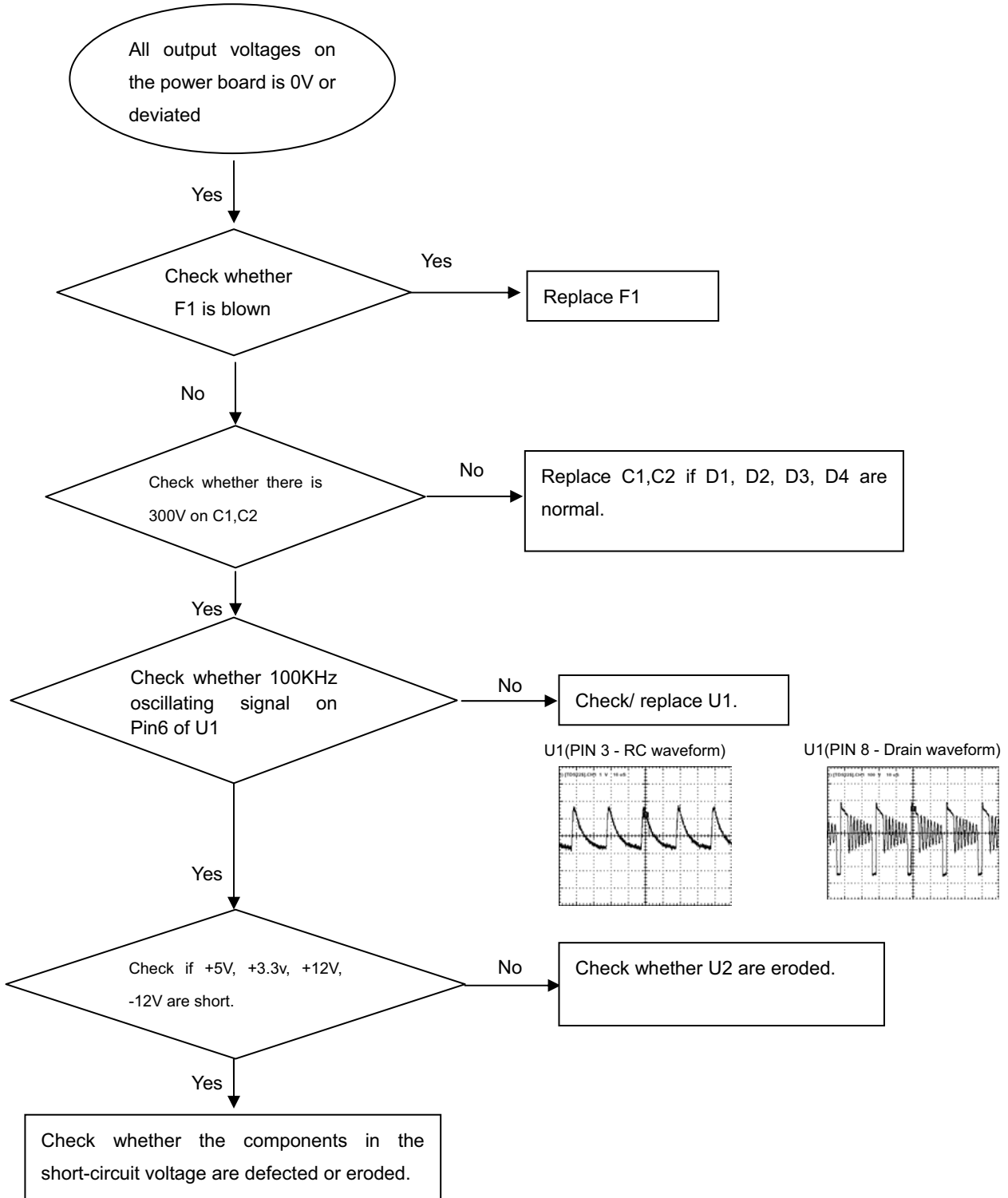

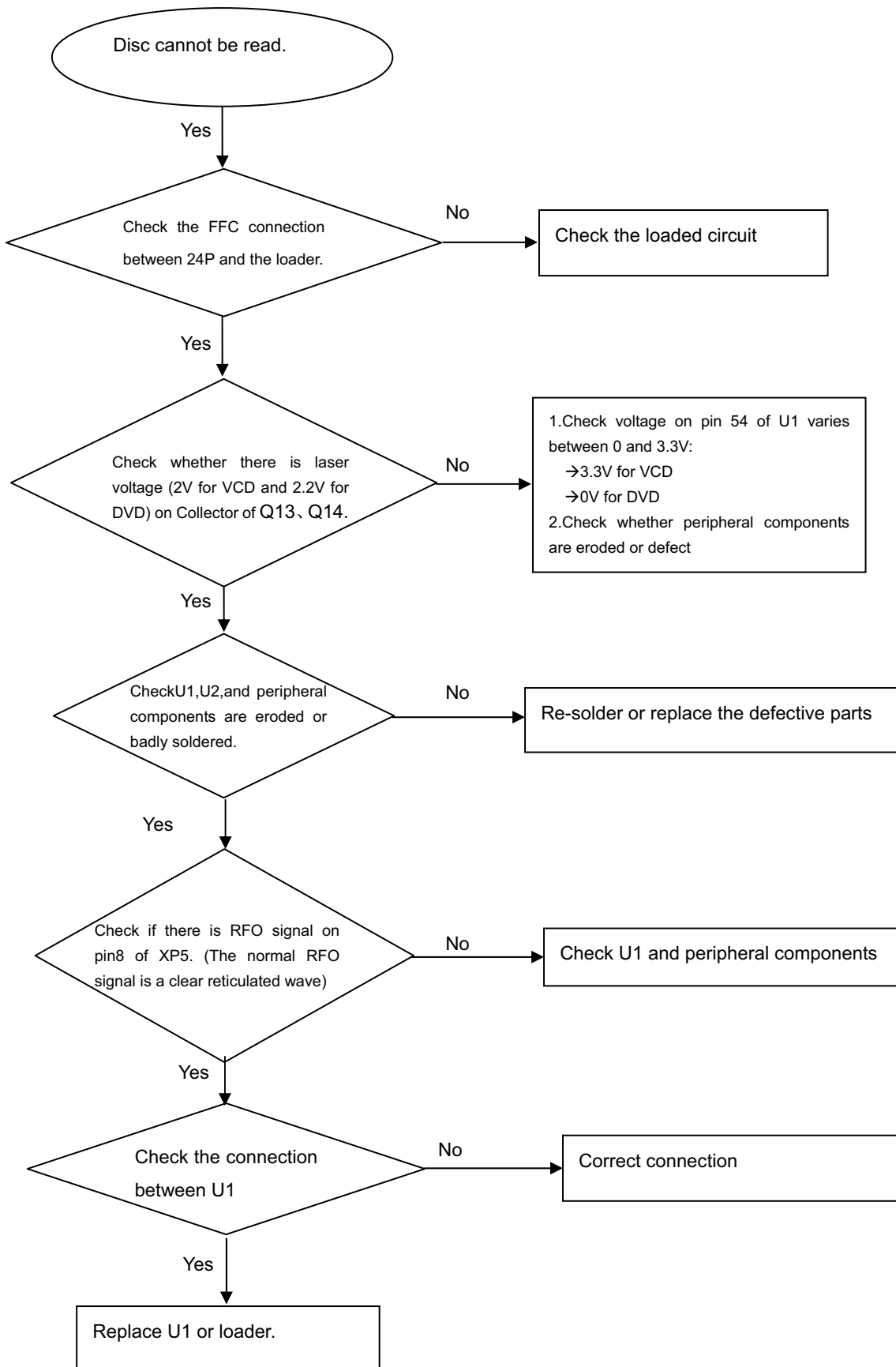
Disc cannot be read.

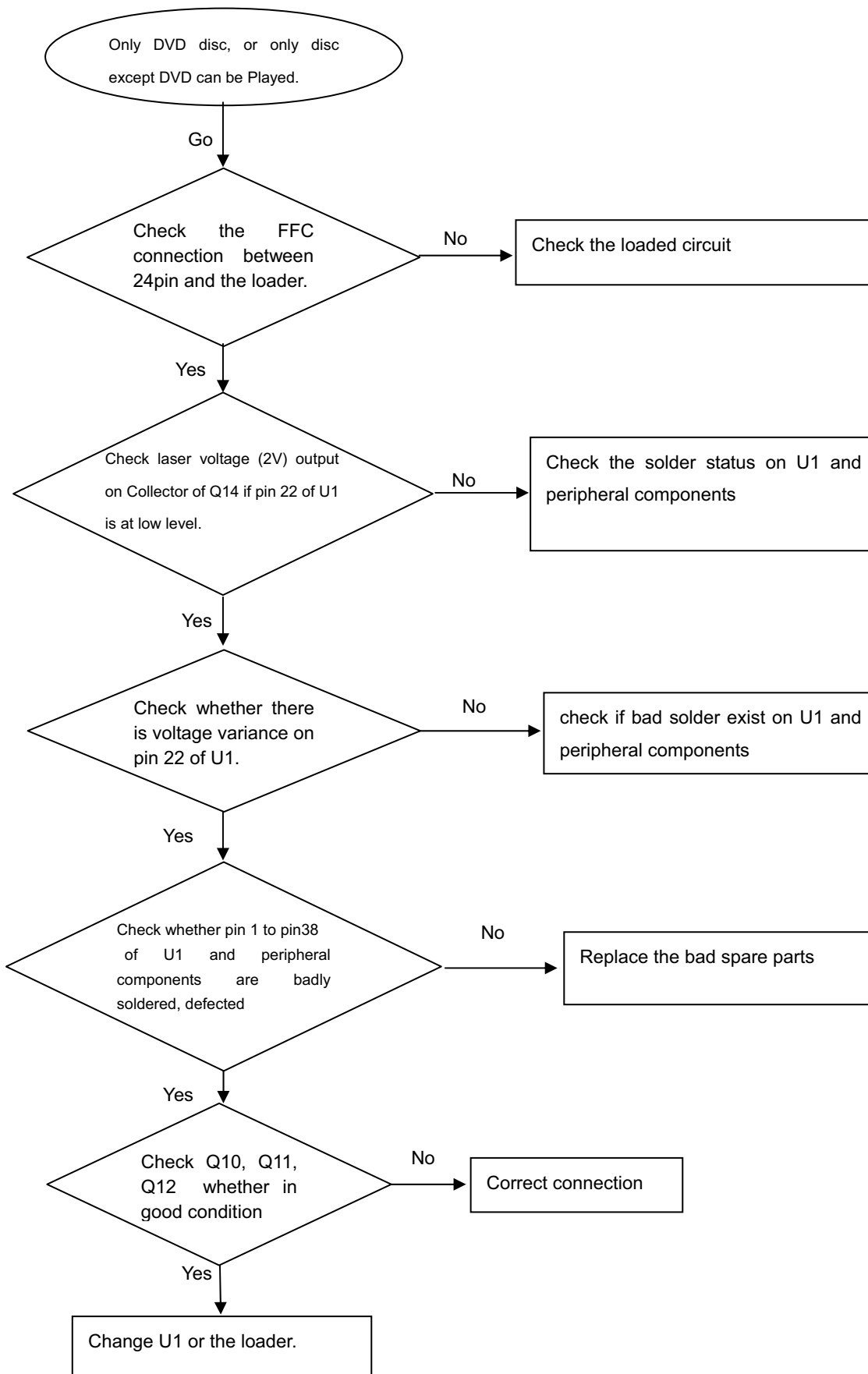
Only DVD disc or only disc except DVD can be played

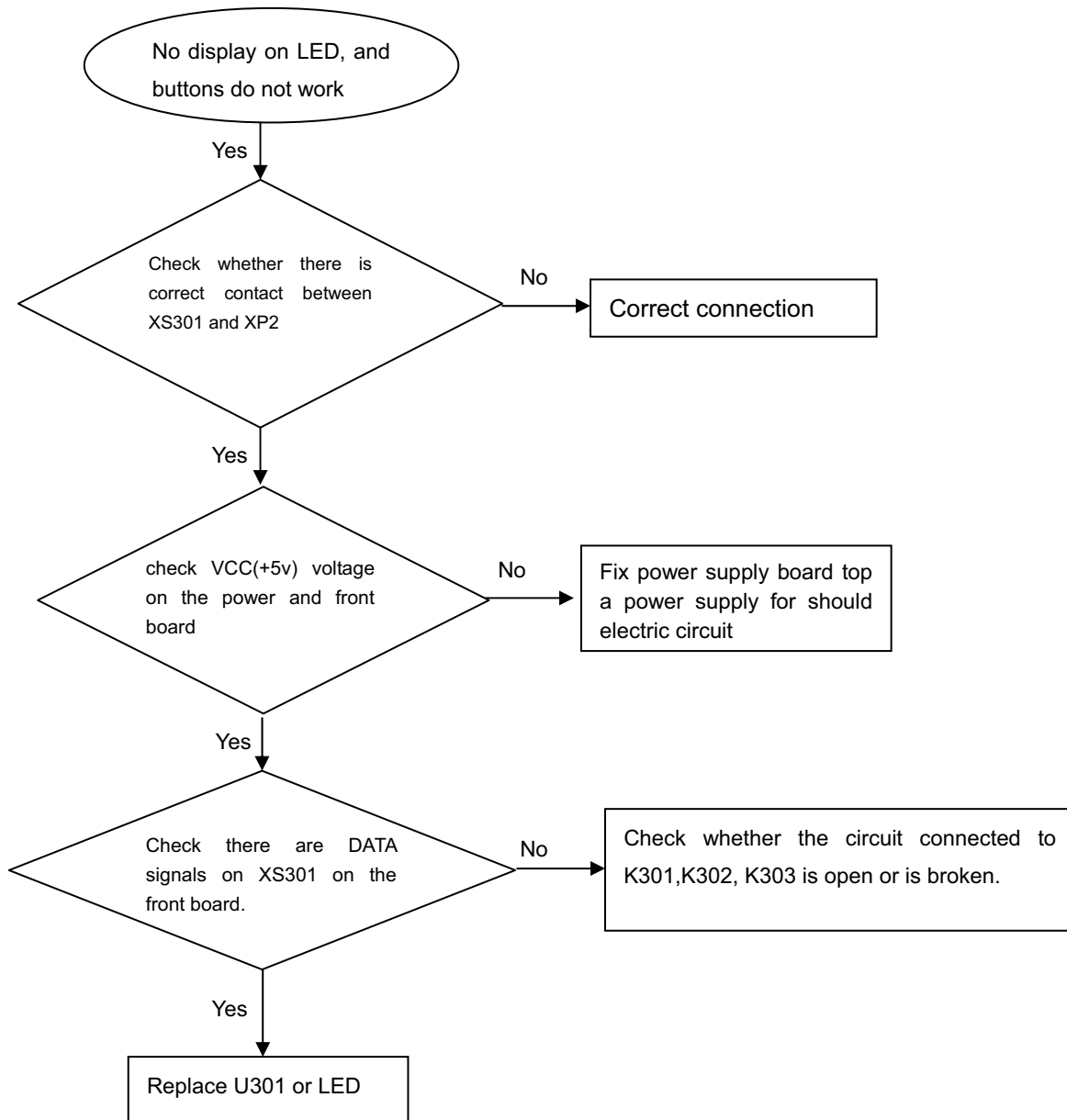
No display on LED, and buttons do not work

Distorted audio and loud noise

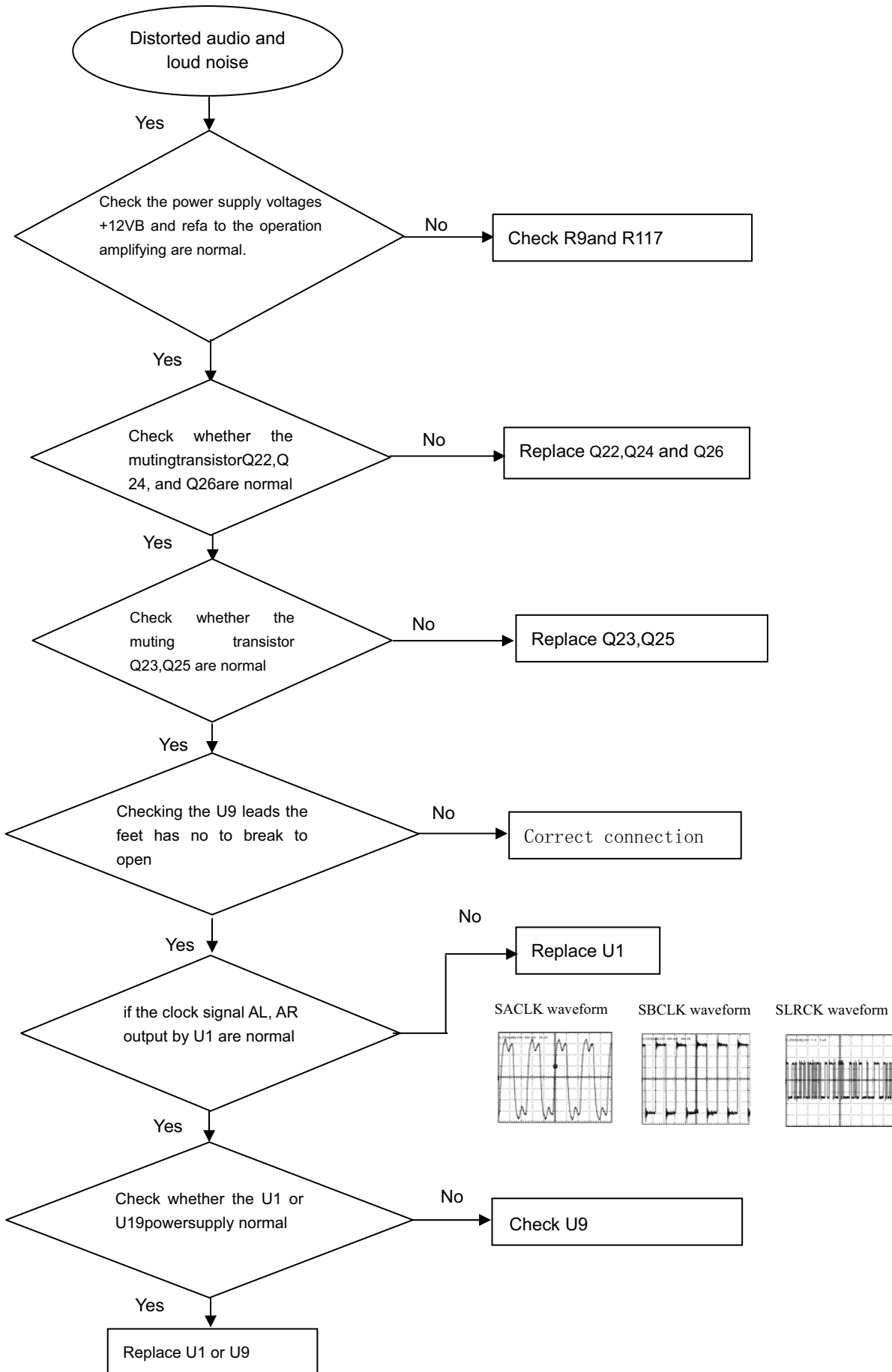

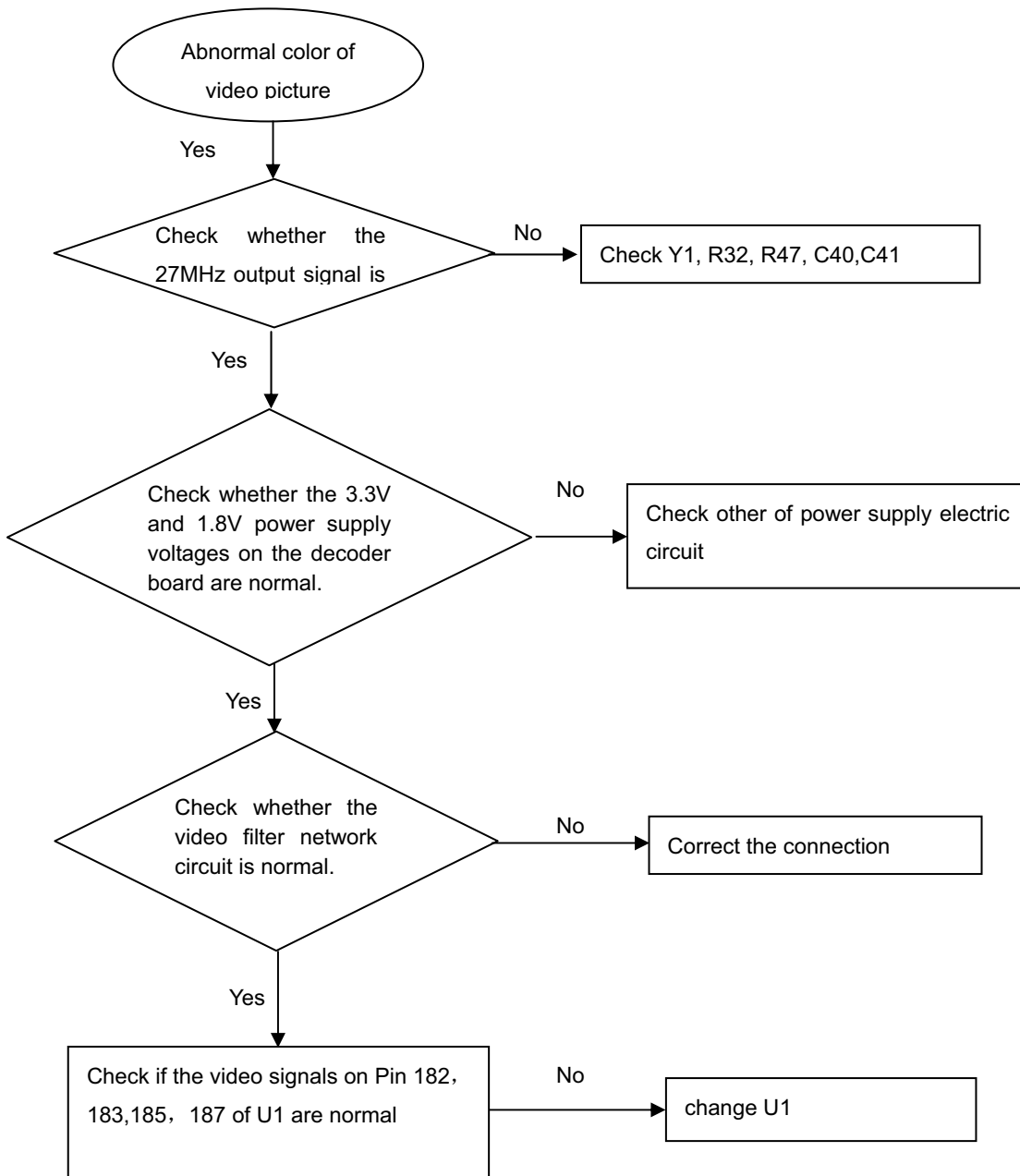
Abnormal color of video picture

Remote reception is insensitive or fails.

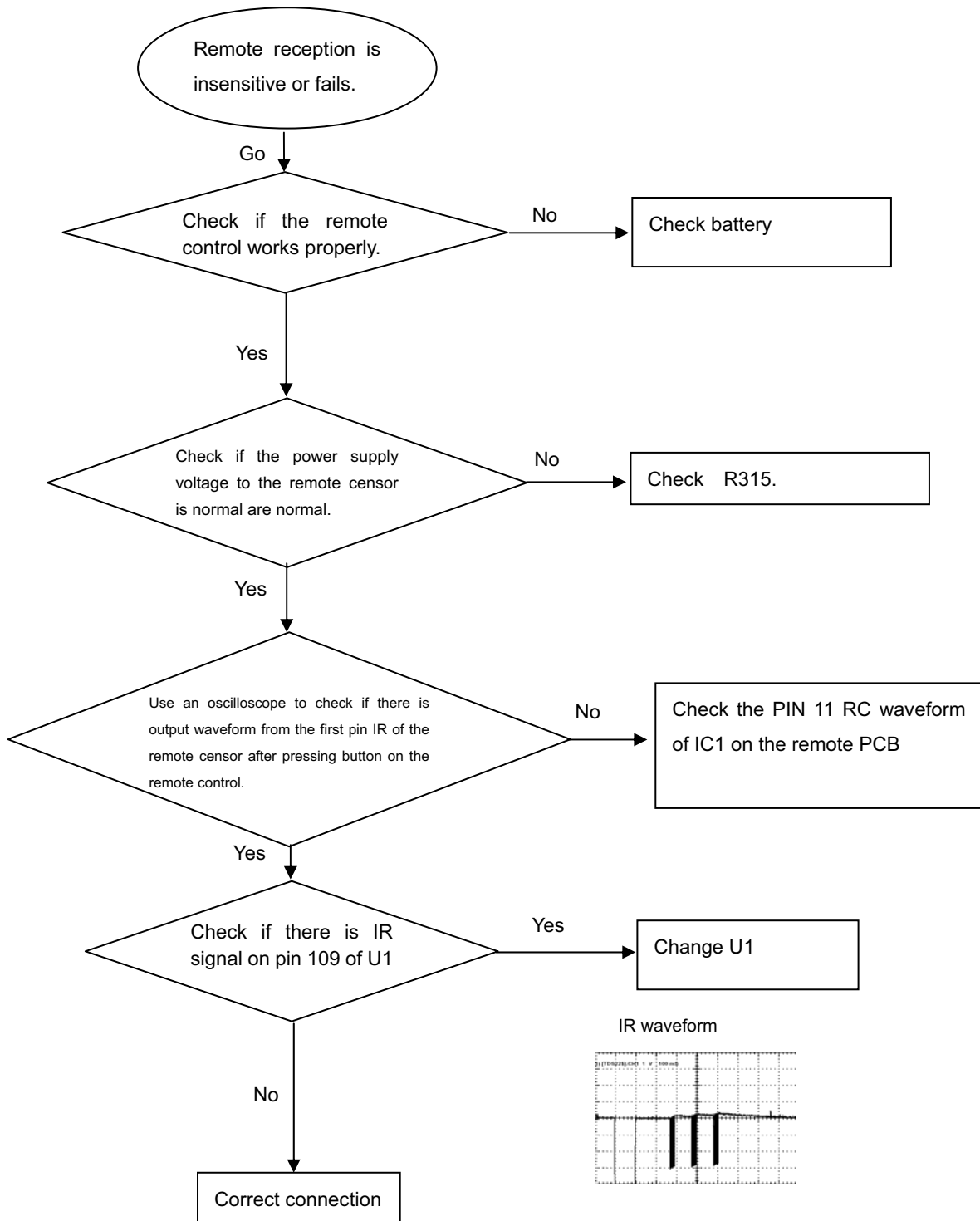

No video picture, no sound.

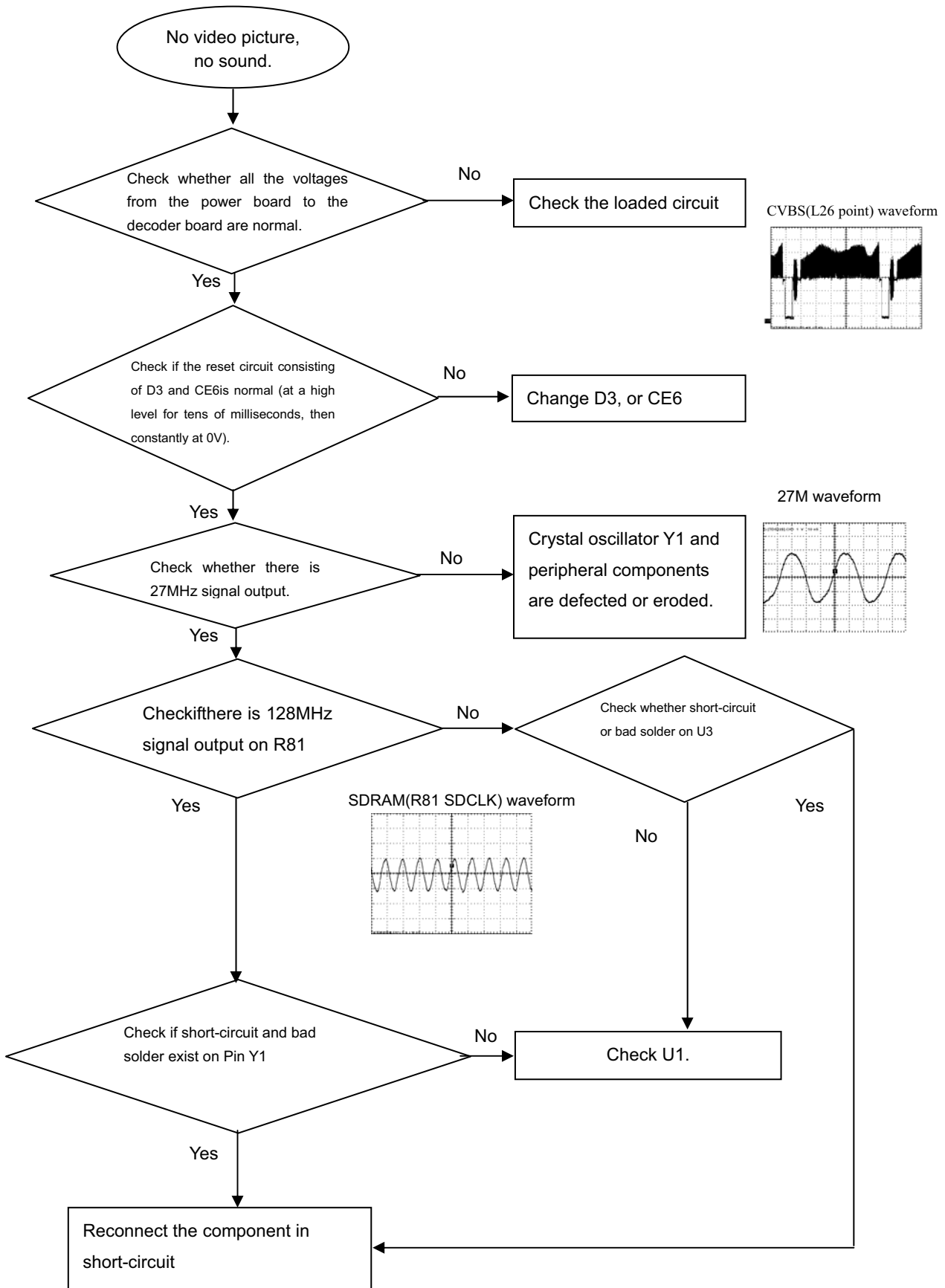

Mechanical and Dismantling Instructions

Dismantling Instruction

Detailed information please refer to the model set.

The following guidelines show how to dismantle the player.

Step1: Remove 5 screws around the Top Cover, and then remove the Top Cover (Figure 1).



Figure 1

Step2: If it is necessary to dismantle Loader or Front Panel, the Front door should be removed first. (Figure 2)

Note: Make sure to operate gently otherwise the guider would be damaged.



Please kindly note that dismantle the front door assembly carefully to avoid damage tray and the front door.

Figure 2

Mechanical and Dismantling Instructions

Dismantling Instruction

Detailed information please refer to the model set.

Step3: If the tray can't open in normal way, you can make it through the instruction as below (Figure 3).

Note: Make sure to operate gently otherwise the guider would be damaged.



Figure 3

Step4: Dismantling Front Panel, disconnect the connectors (XP2, XP6, XP7), need release 4 snaps of Front Panel and 2 snaps of bottom cabinet, then gently pull the Panel out from the set. (Figure 4 - Figure 6)

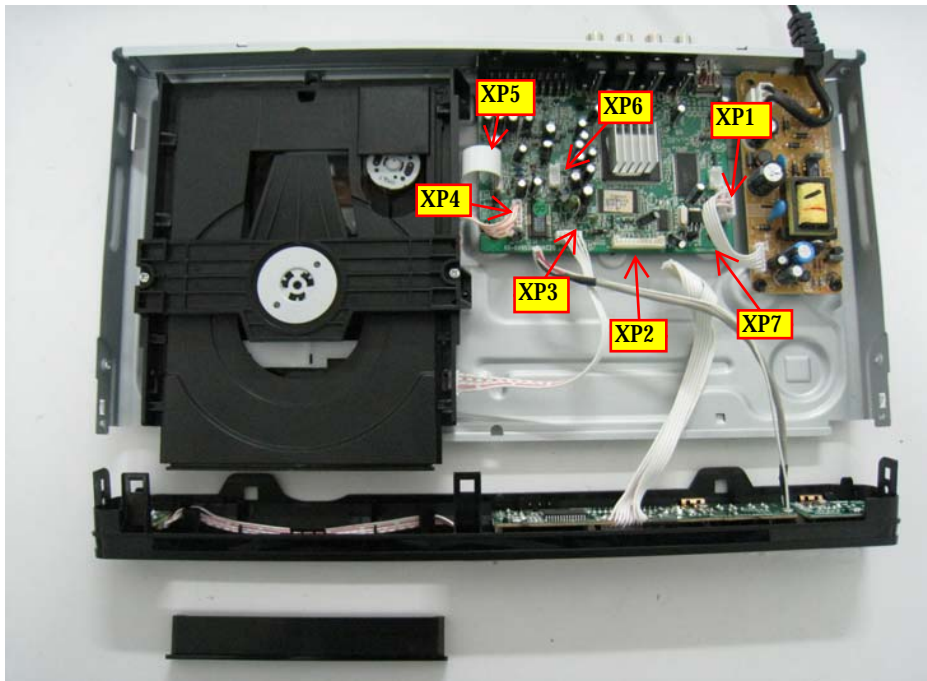

Figure 4

Mechanical and Dismantling Instructions

Dismantling Instruction

Detailed information please refer to the model set.

Step5: Dismantling Loader, disconnect the 3 connectors (XP3, XP4, XP5) aiming in the below figure, and remove 1 screw that connects the loader and the bottom cabinet. (Figure 5)

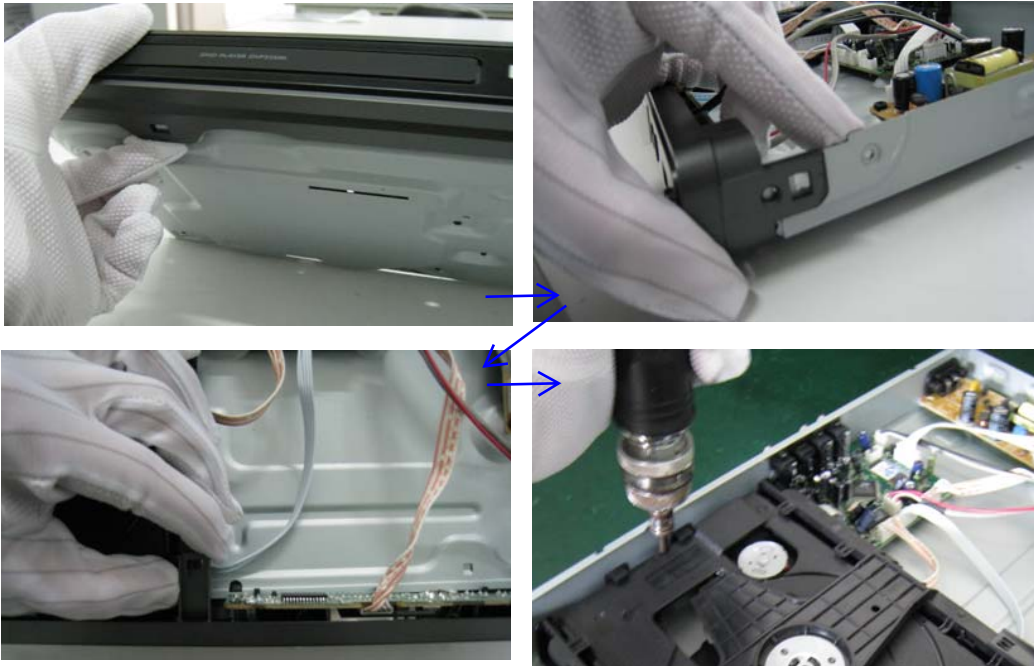

Figure 5

Step6: Dismantling Main Board, first disconnect the connector (XP1), and then remove 6 screws. (Figure 6)

Step7: Remove the 2 screws on Power Board to dismantle the Power Board. (Figure 6)

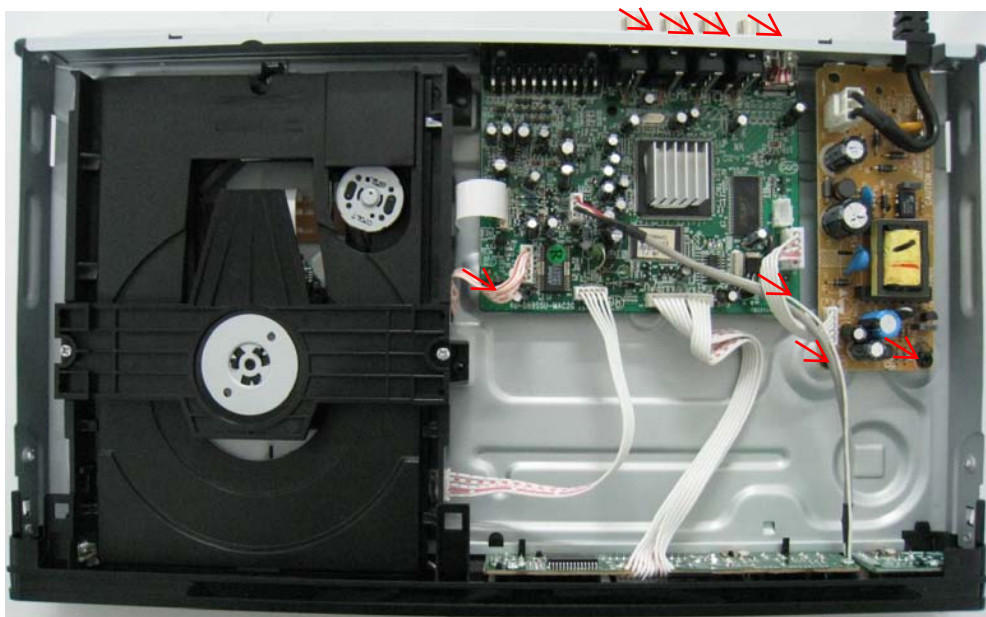

Figure 6

Software upgrade

Preparation to upgrade software *

- 1) Start the CD Burning software and create a new CD project (Data Disc) with the following setting:
 Label: DVP3XX (No need the label name)
 File Name: DVPXXXXX_XX.BIN
 Power on the set and open the tray, then press <5><5> to check the File Name.

Note: It is required capital letter for the File System name.

- 2) Burn the data onto a blank CDR

A. Procedure for software upgrade:

- 1) Power on the set and insert the prepared Upgrade CDR.
- 2) The set will starts reading disc & response with the following display TV screen:
 Upgrade File DETECTED
 Upgrade?
 Press Play TO START.
- 3) Press <OK> button to confirm, then screen will display :
 Files coping...
 UPGRADING...
- 4) The upgraded tray will automatically open when files coping complete, then take out the disc.
- 5) About 1 minute later, the trace will automatically close when upgrading complete.

B. Read out the software versions to confirm upgrading

- 1) Power on the set and press <Setup> button on the remote control.
- 2) Press<1><3><7><9> button or press down cursor on remote control to choose "Preference" and press right & down cursors to choose "Version Info".

The software version and other information are display on the TV screen as follows:

Model	DVP33XXX XX
File Name	DVP33XXX XX.BIN
Version	XX.XX.XX.XX
RISC	XX.XX.XX.XX
Servo	XX.XX.XX.XX
Region Code	X
HDCP	PASS(except press<1><3><7><9>)

* The other upgrade SW way is by memory, the steps are the same as CDR's, create the upgrade file into memory, and connect the USB flash drive to the USB socket on set, then press "USB" on remote control to access the content and play the upgrade file as above upgrade procedure.

Caution: The set must not be power off during upgrading, Otherwise the Main board will be damaged entirely.

Region Code Change

- 1) Power on the set and open the tray door;
- 2) Press the "Setup" button on the remote control, then the setup interface should be displayed on the TV screen;
- 3) Move the down cursor on remote control to choose "Reference" and press "1" "3" "8" "9" "3" "1" on the remote control;
- 4) Then move the up or down cursors to choose the region code.

Note: restart after above steps.

DVP3386K & DVP3388K WIRING DIAGRAM

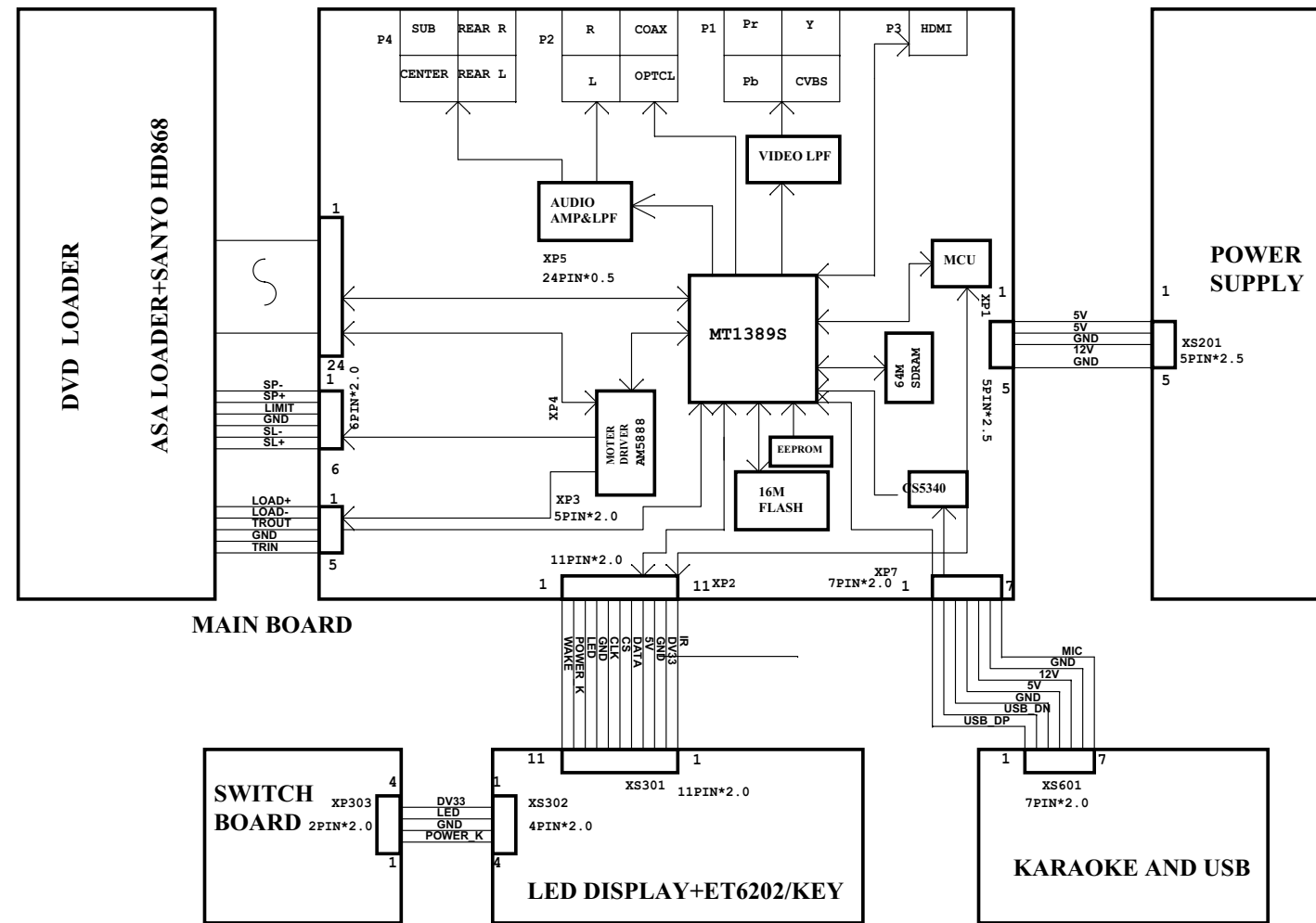

Remarks: DVP338X/37,DVP338XK/55/98

Front Board Electric Diagram

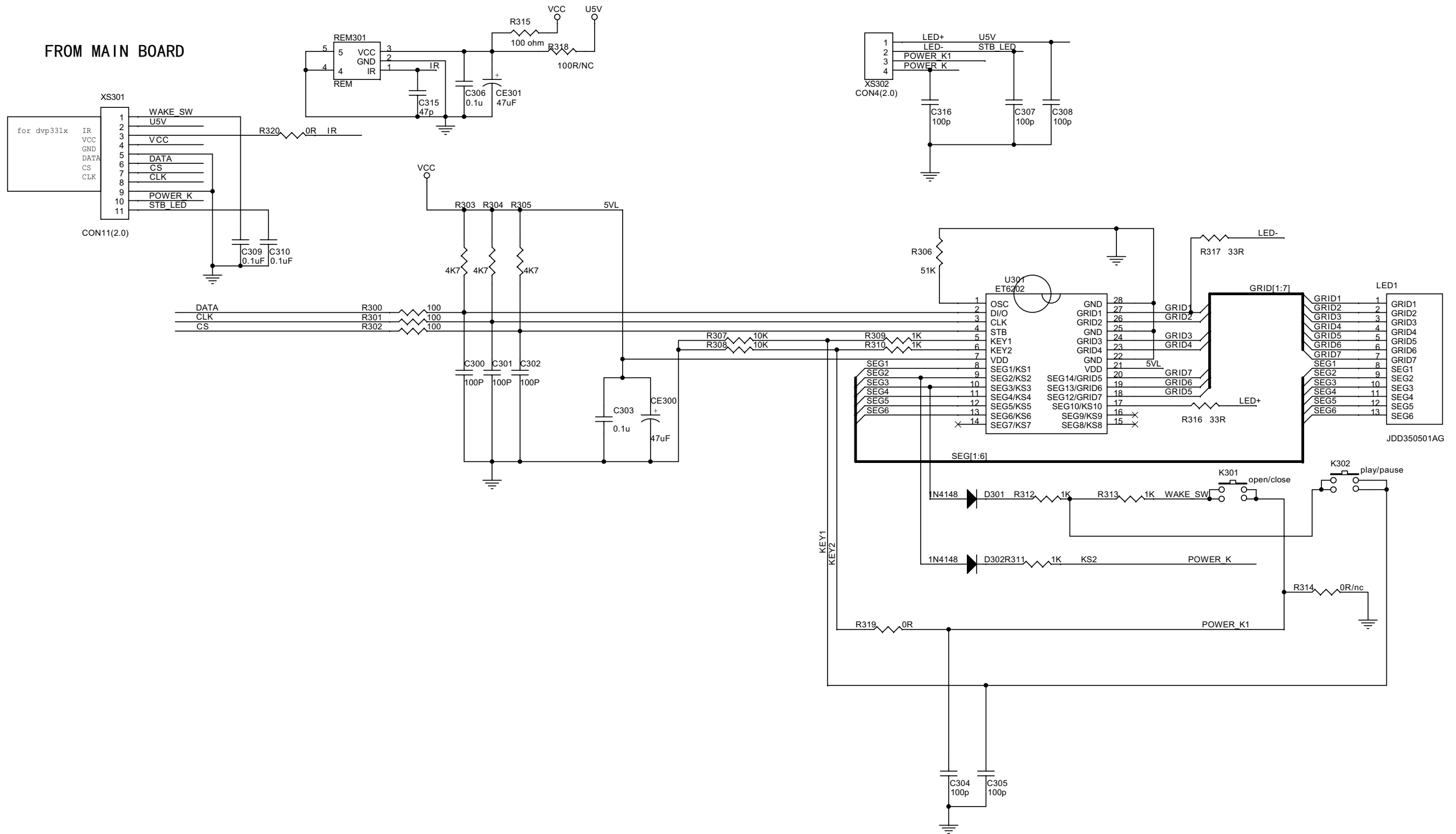

Switch Board Electric Diagram

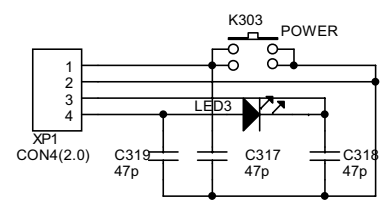

SWITCH BOARD

OK Board & USB Board Electric Diagram

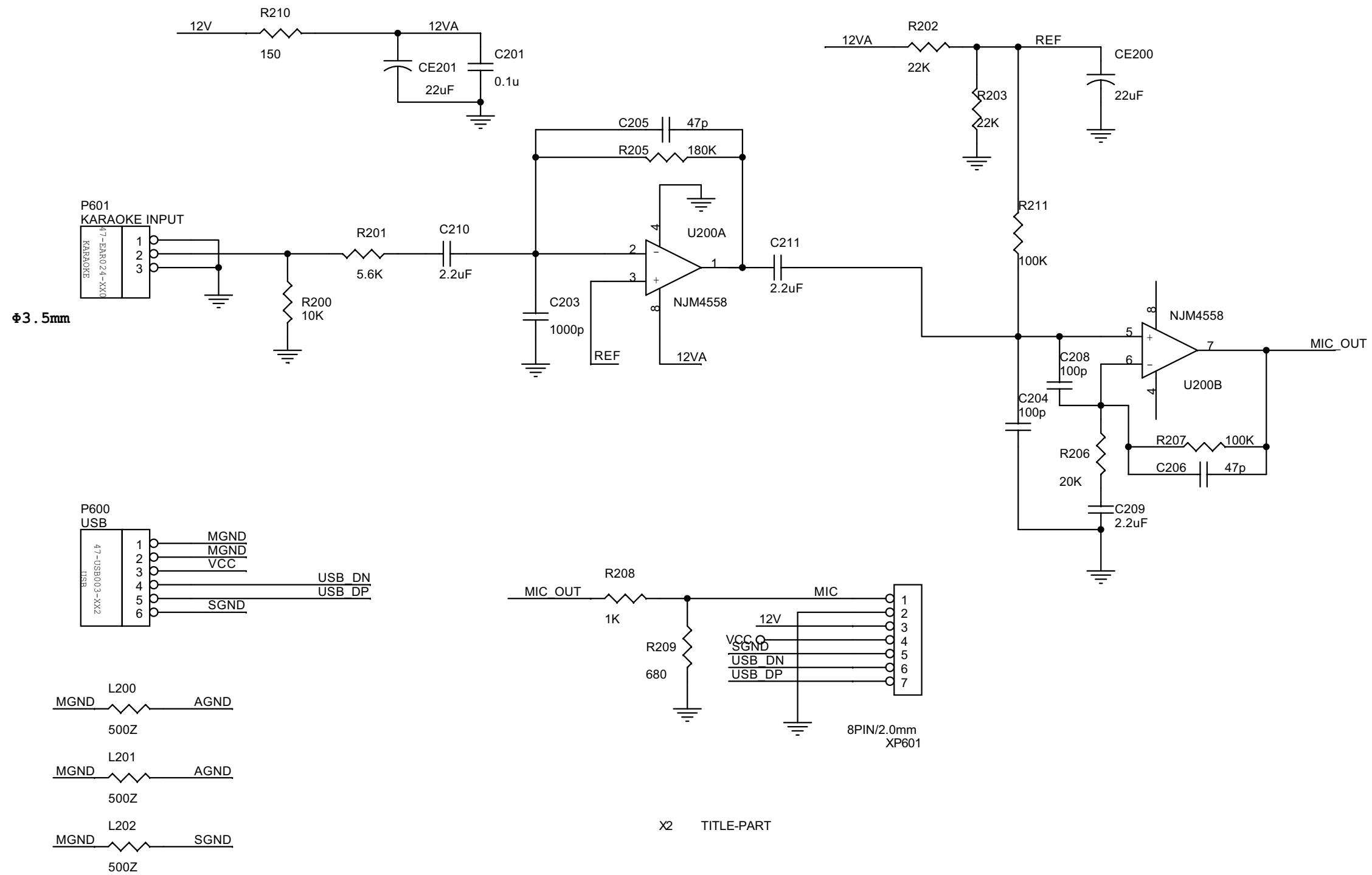

Remark: DVP3368/94 has not Karaoke output.

Power Board Electric Diagram for DVP3388K/96:

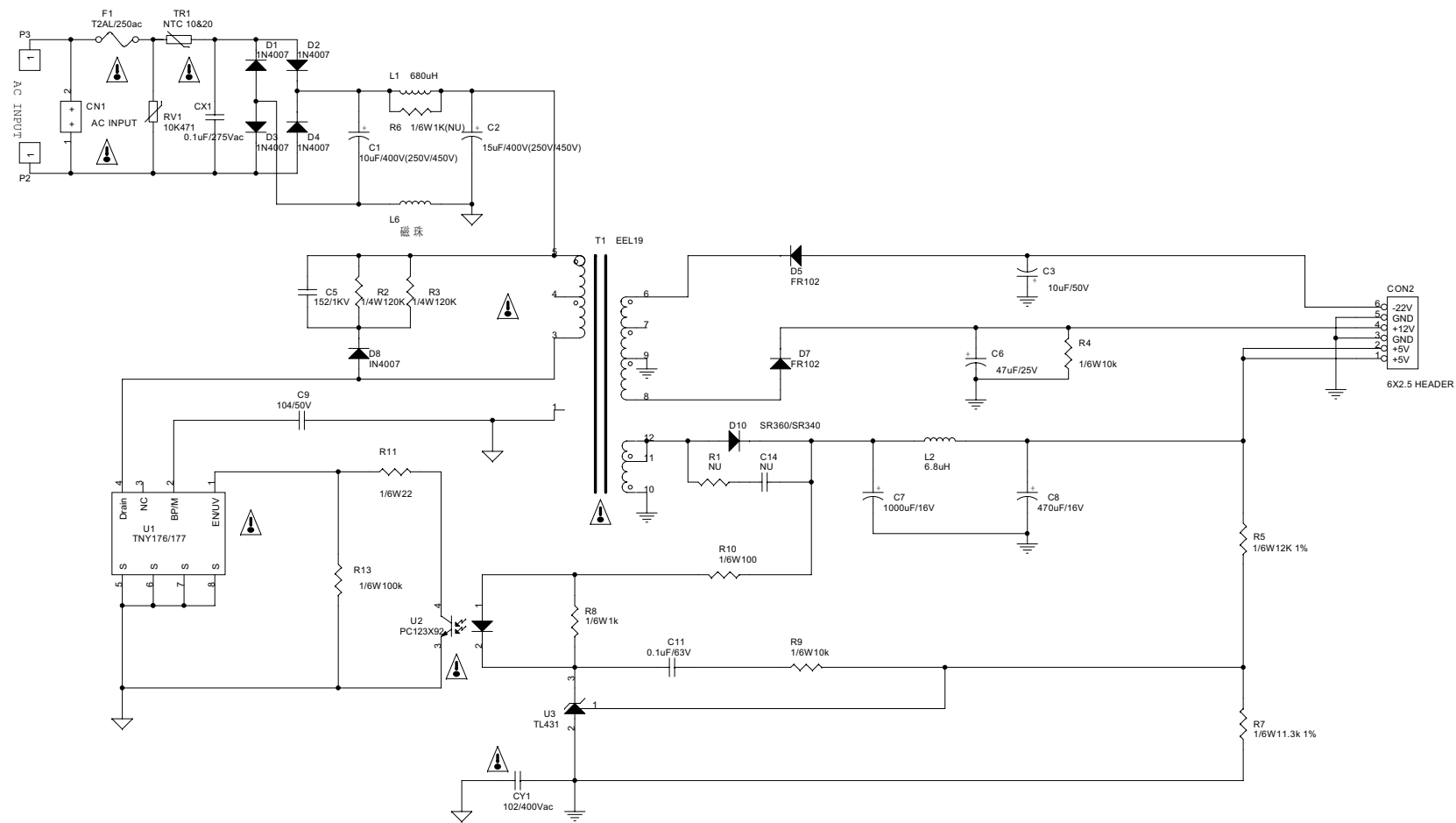

*** CAUTION :**
 THE PARTS MARKED WITH  ARE IMPORTANT PARTS ON THE SAFETY.
 PLEASE USE THE PARTS HAVING THE DESIGNATED PARTS NUMBER WITHOUT FAIL.

Main Board Electric Diagram: Power Supply

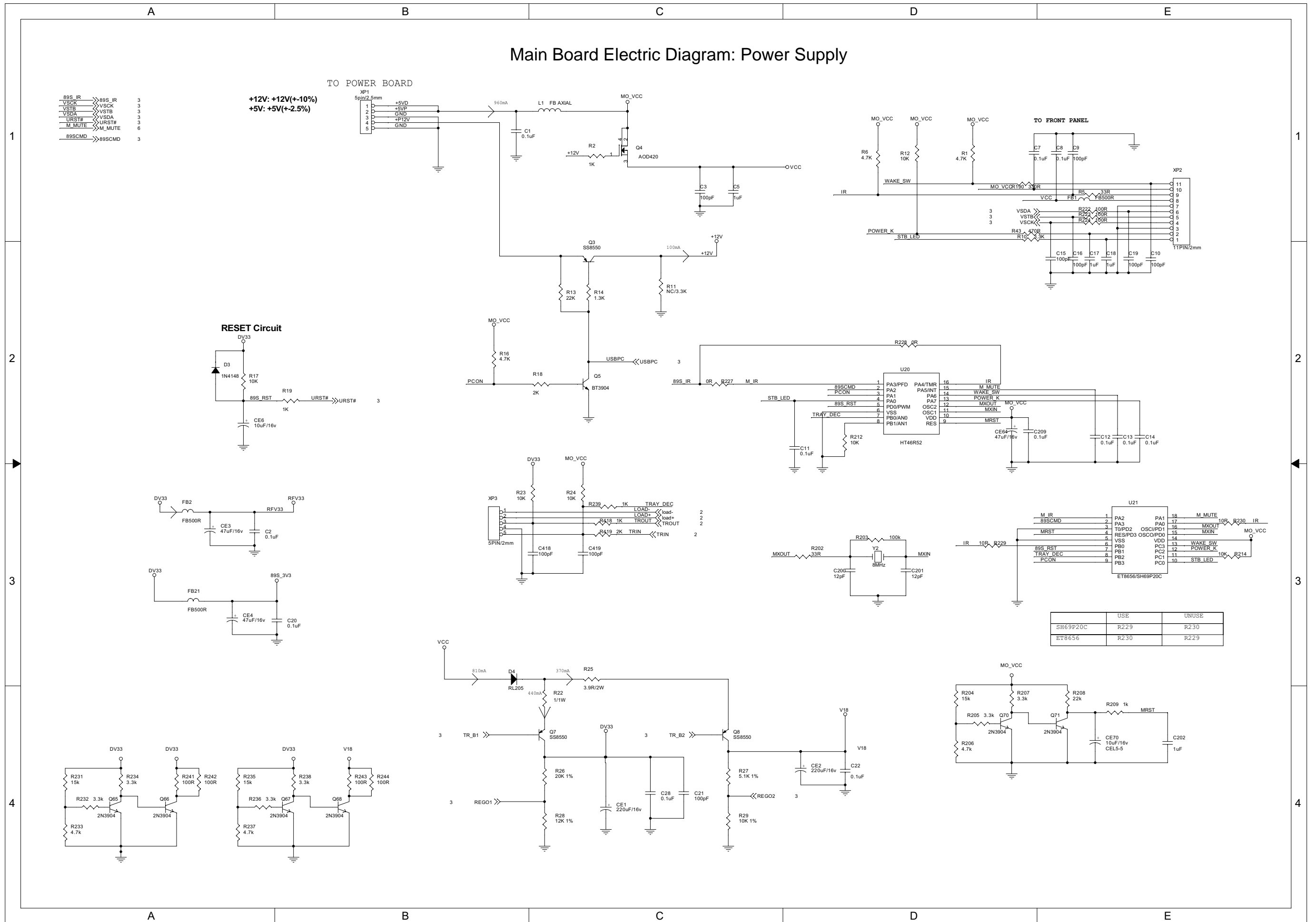

- 89S_IR >> 89S_IR 3
- V_SCK >> V_SCK 3
- V_STB >> V_STB 3
- V_SDA >> V_SDA 3
- URST# >> URST# 3
- M_MUTE >> M_MUTE 6
- 89SCMD >> 89SCMD 3

+12V: +12V(+10%)
+5V: +5V(+2.5%)

RESET Circuit

	USE	UNUSE
SH69P20C	R229	R230
ET8656	R230	R229

Main Board Electric Diagram: MT1389S

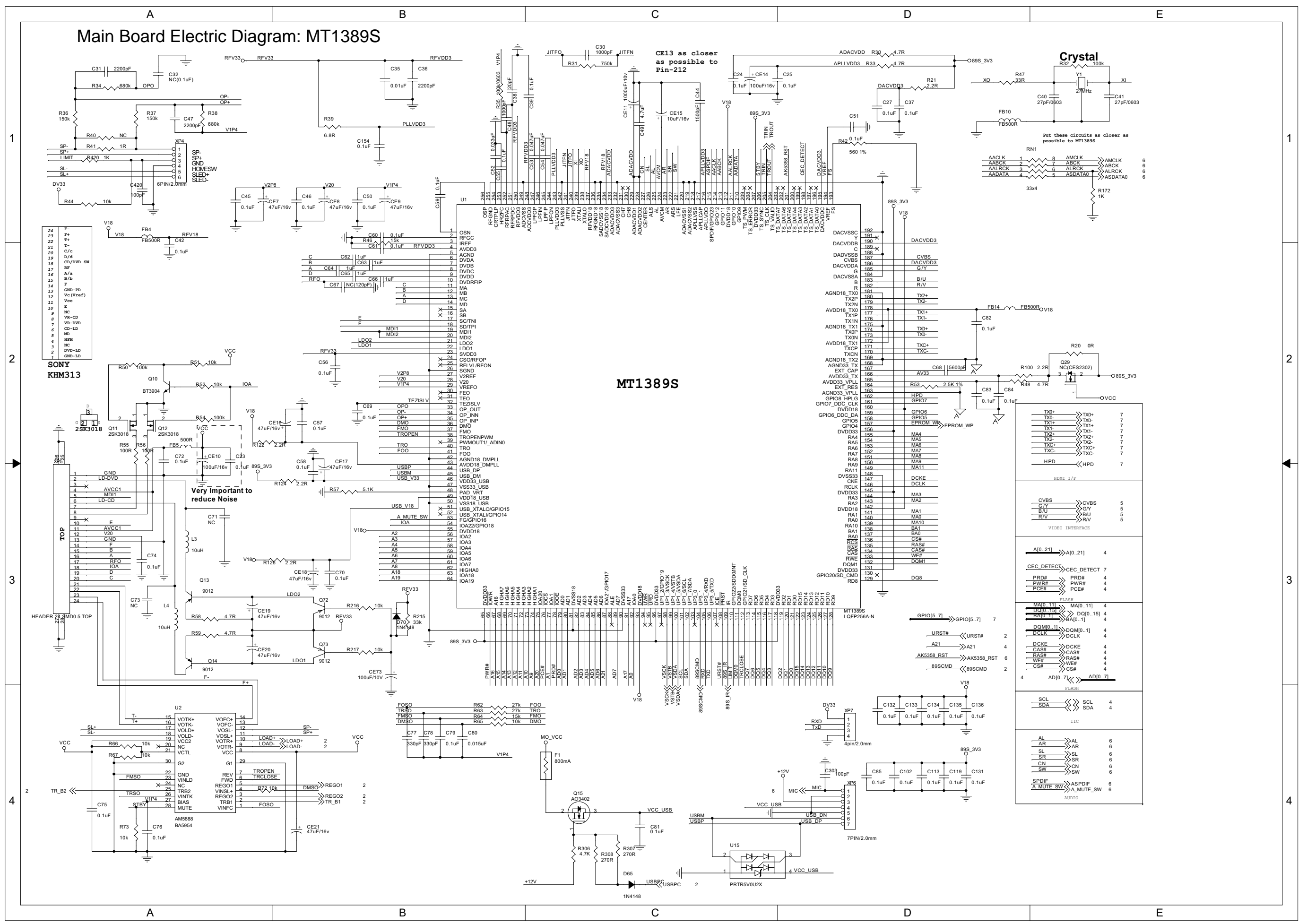

SONY KHM313

24	F-
23	F+
22	F-
21	F-
20	C/c
19	D/4
18	CD/DVD SW
17	RF
16	A/a
15	B/b
14	F
13	GND-PD
12	Vc (Vzref)
11	E
10	VR-CD
9	VR-DVD
8	CD-LD
7	HD
6	HFM
5	NC
4	NC
3	DVD-LD
2	GND-LD

Very important to reduce Noise

MT1389S

Crystal

Put these circuits as closer as possible to MT1389S

AACLK	1	8	AMCLK	6
AABCK	2	7	ABCK	6
AALCK	3	6	ALCK	6
AADATA	4	5	ASDATA0	6

TX0+	TX0+	7
TX0-	TX0-	7
TX1+	TX1+	7
TX1-	TX1-	7
TX2+	TX2+	7
TX2-	TX2-	7
TXC+	TXC+	7
TXC-	TXC-	7
HPD	HPD	7

CVBS	CVBS	5
G/Y	G/Y	5
B/U	B/U	5
R/V	R/V	5

A[0..21]	A[0..21]	4
CEC_DETECT	CEC_DETECT	7
PRD#	PRD#	4
PWR#	PWR#	4
PCE#	PCE#	4

MA[0..15]	MA[0..15]	4
DA[0..15]	DA[0..15]	4
BA[0..15]	BA[0..15]	4
DOM[0..15]	DOM[0..15]	4
DCLK	DCLK	4

DCKE	DCKE	4
CAS#	CAS#	4
RAS#	RAS#	4
WE#	WE#	4
CS#	CS#	4

SCL	SCL	4
SDA	SDA	4

AL	AL	6
AR	AR	6
SL	SL	6
SR	SR	6
CN	CN	6
SW	SW	6
SPDIF	ASPDIF	6
A_MUTE_SW	A_MUTE_SW	6

Main Board Electric Diagram: SDRAM & FLASH

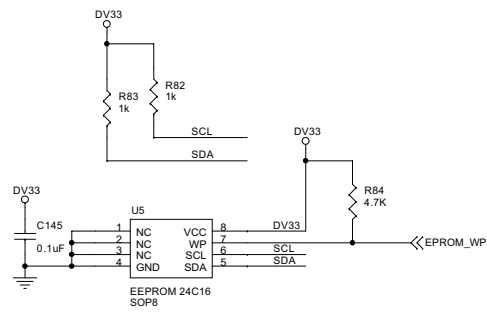
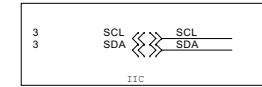
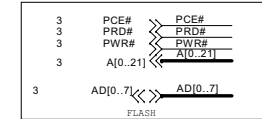
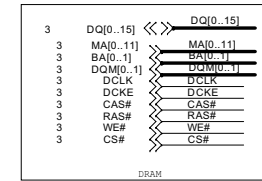
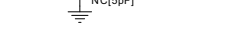
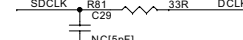
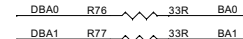
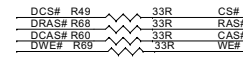
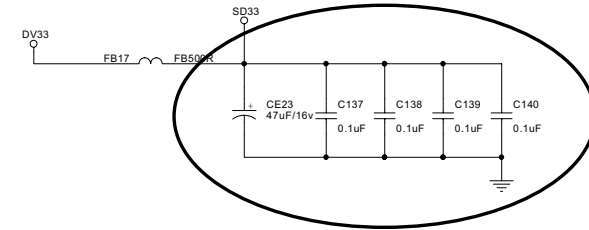
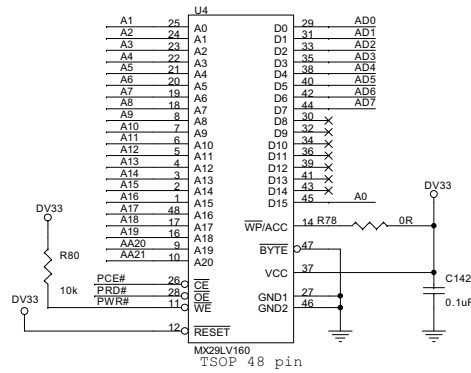
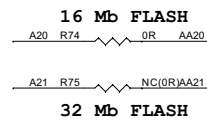
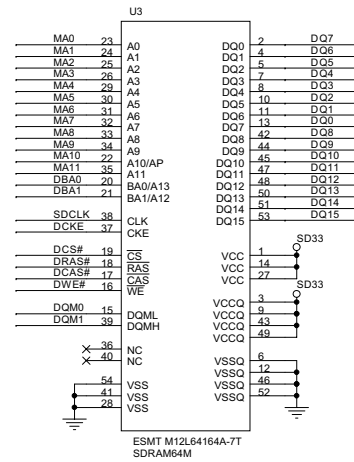

Main Board Electric Diagram: VIDEO OUTPUT & AV-CONNECTOR

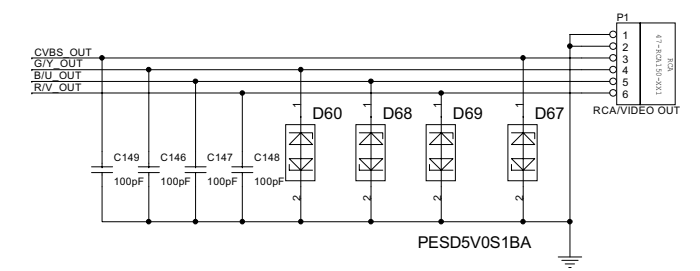
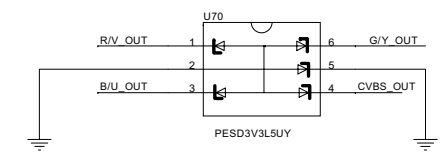
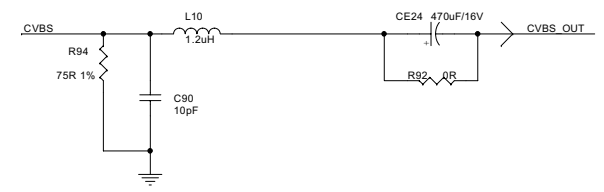
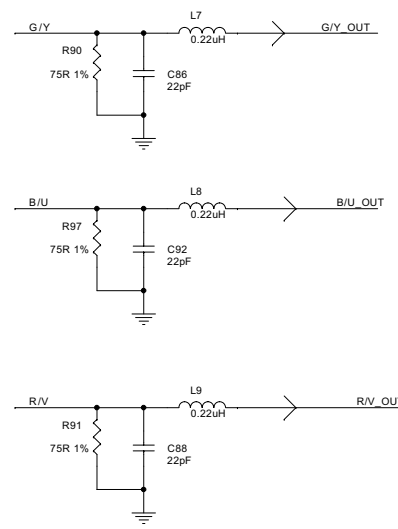

CVBS	← CVBS	3
G/Y	← G/Y	3
B/I	← B/I	3
R/V	← R/V	3

VIDEO I/T

Main Board Electric Diagram: AUDIO OUTPUT

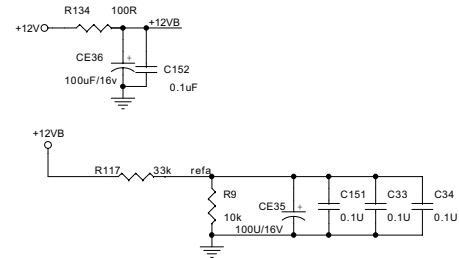
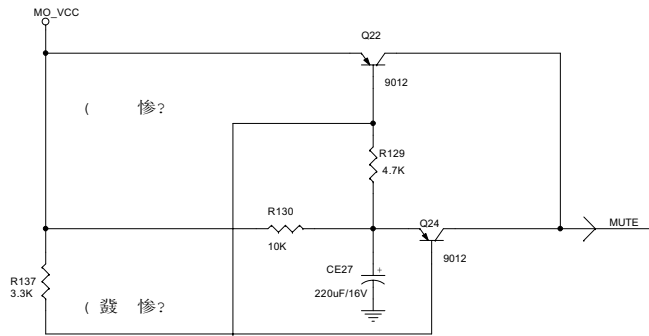
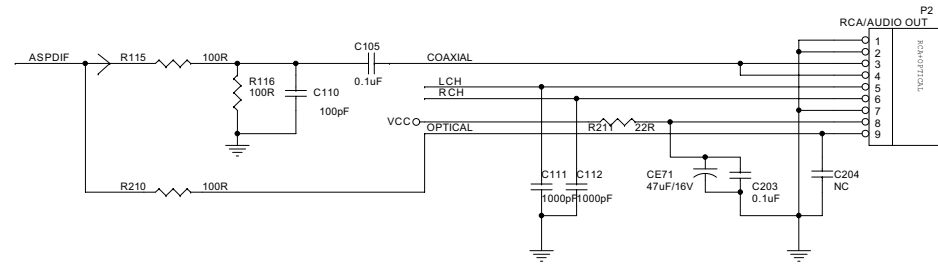
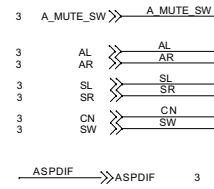

mute circuit

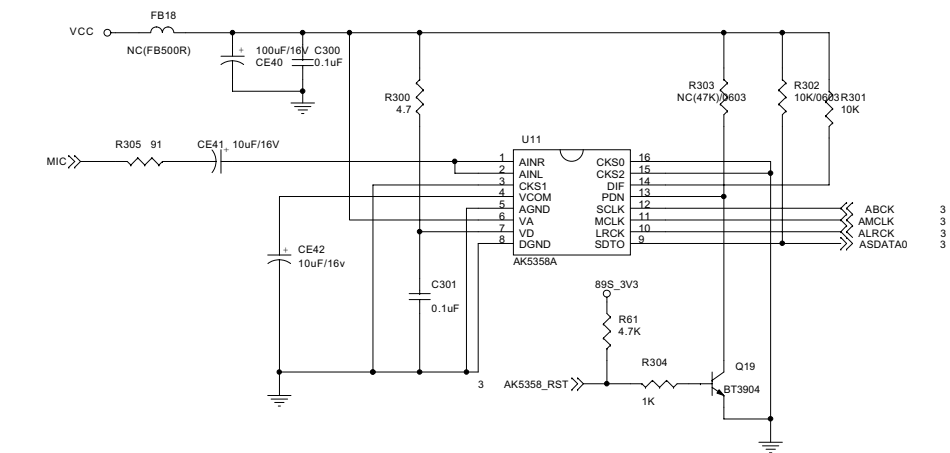

DIF PULL UP:I2S
 CKS0,CKS1,CKS2 PULL Down:CLOCK SLAVE,ALL SPEED MODES

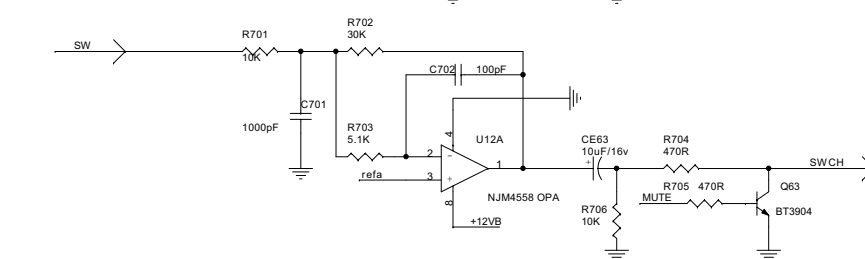
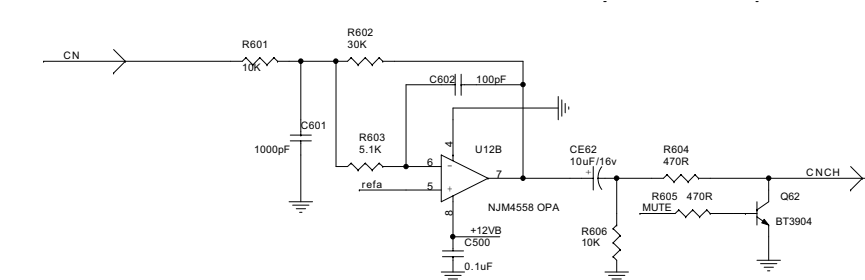
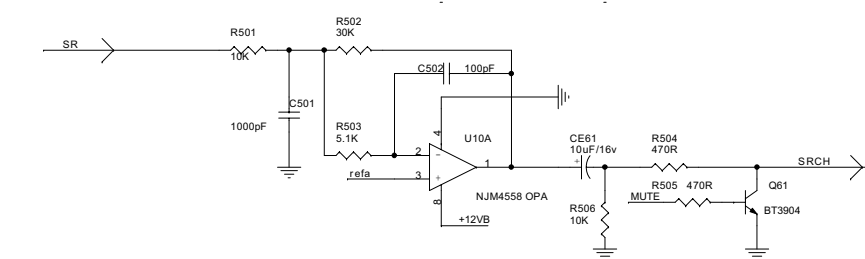
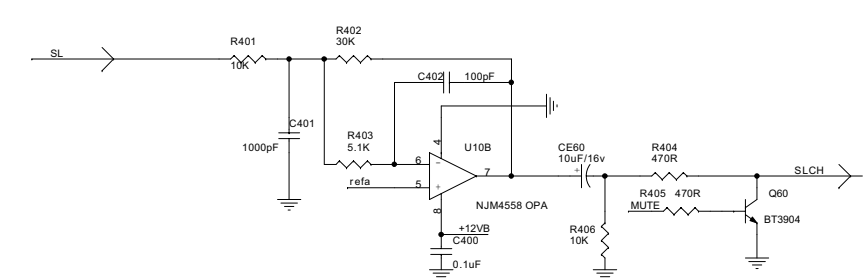
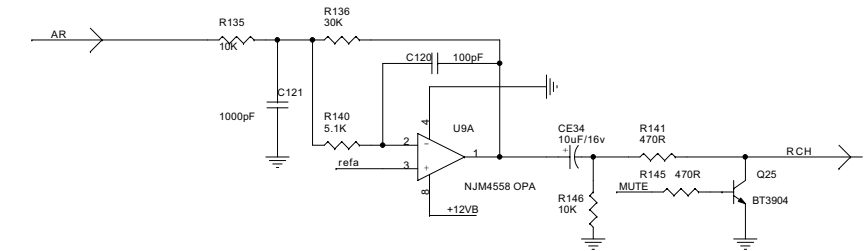
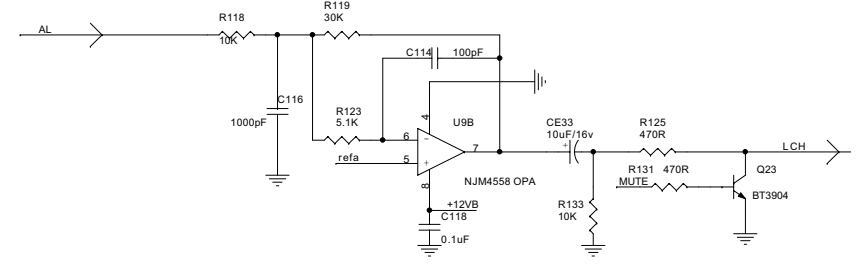

Main Board Electric Diagram: HDMI I/F

TXC+	<< TXC+	3
TXC-	<< TXC-	3
TX0+	<< TX0+	3
TX0-	<< TX0-	3
TX1+	<< TX1+	3
TX1-	<< TX1-	3
TX2+	<< TX2+	3
TX2-	<< TX2-	3
HPD	<< HPD	3
GPIO[5..7]	<< GPIO[5..7]	3
CEC_detect	<< CEC_detect	3

TMDS I/F

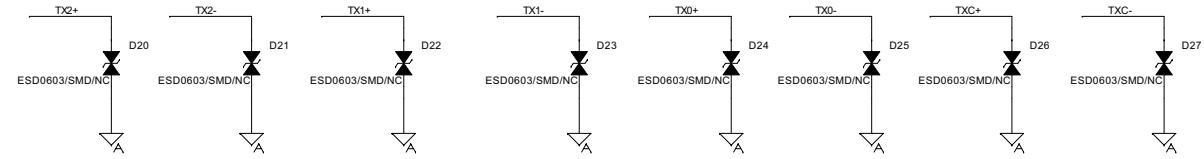

Differential Signal !
 No through hole & length less than 5cm !
 100 ohm - Impedance

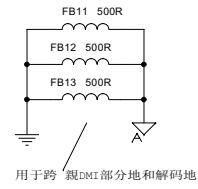
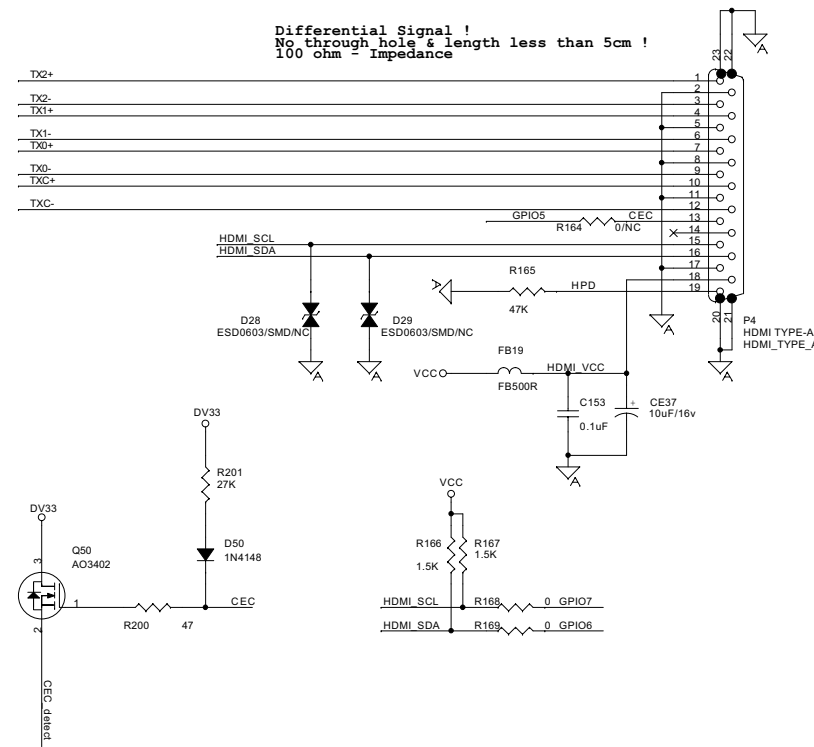

Main Board Print-layout (Bottom side):

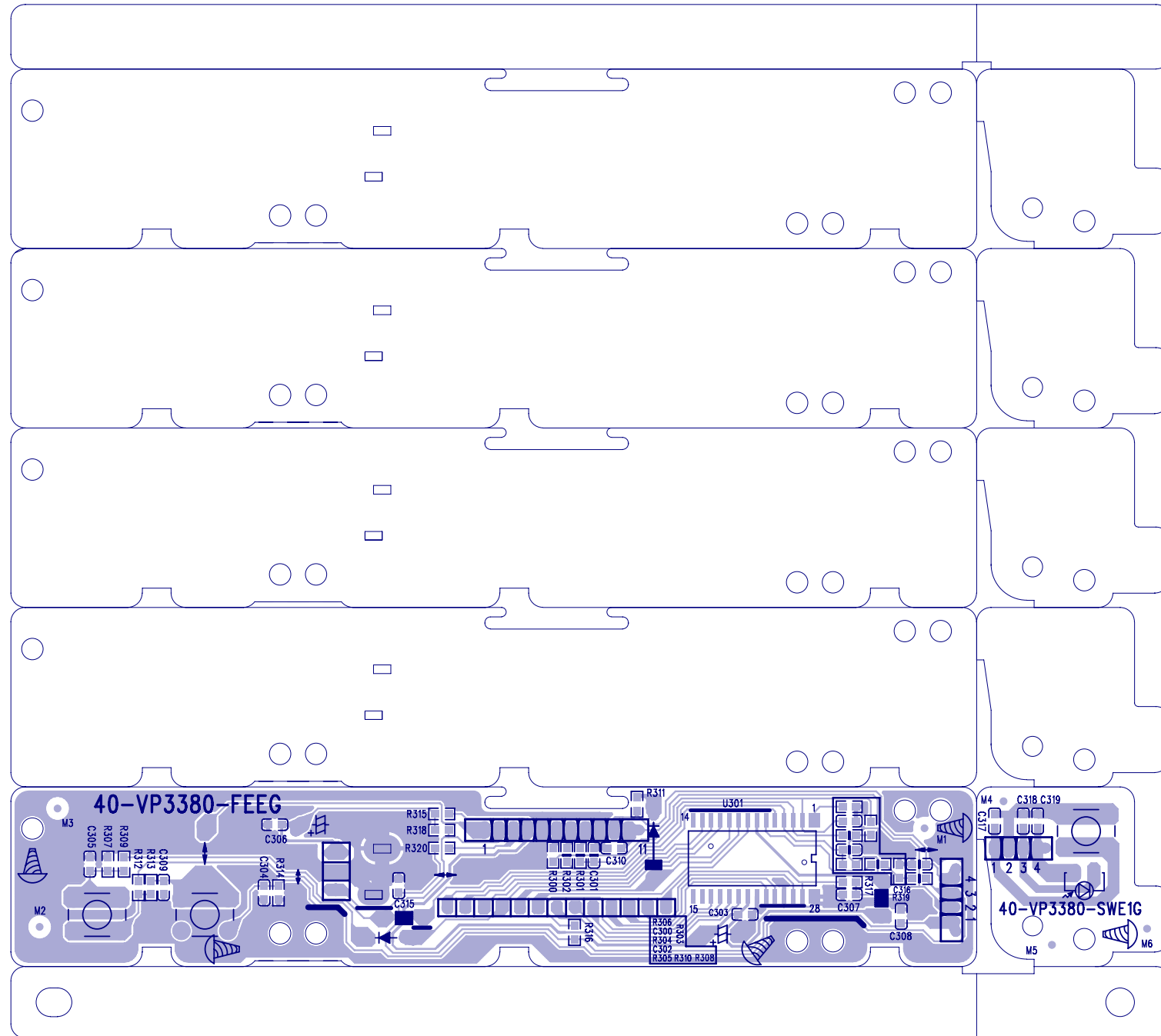

OK+USB Board Print-layout (Top side)

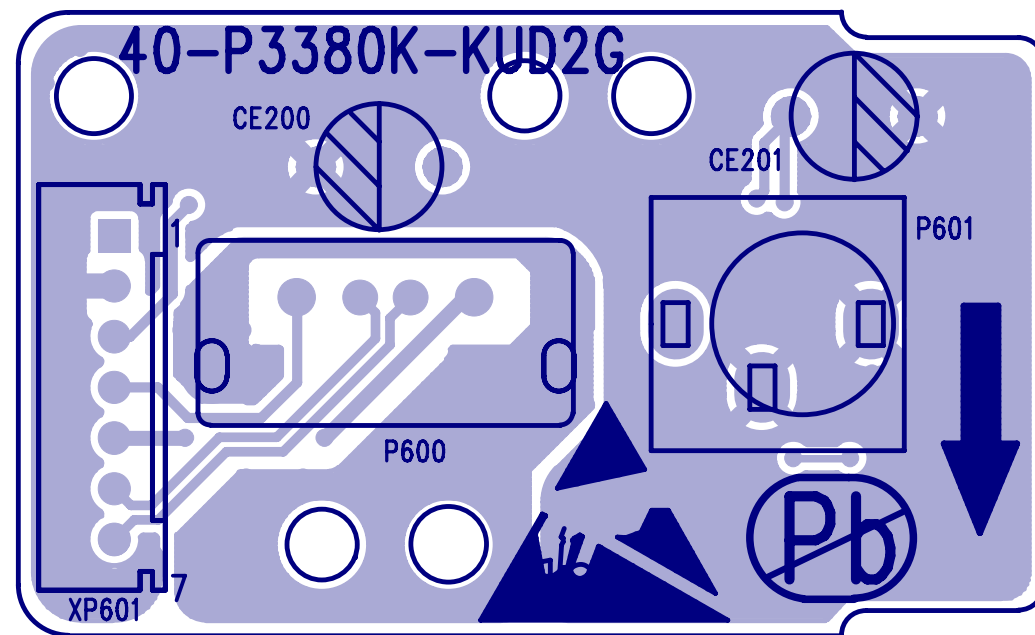

OK+USB Board Print-layout (Bottom side):

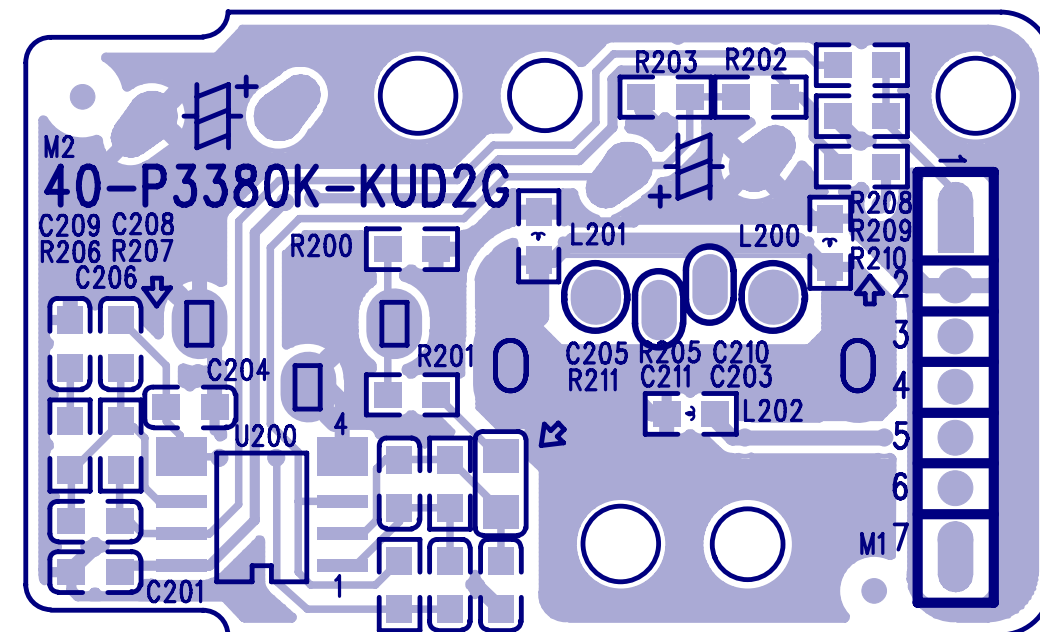

Remark: DVP3368/94 has not Karaoke output.

Power Board Print-layout for DVP3386K/93 & DVP3388K/98 (Bottom side):

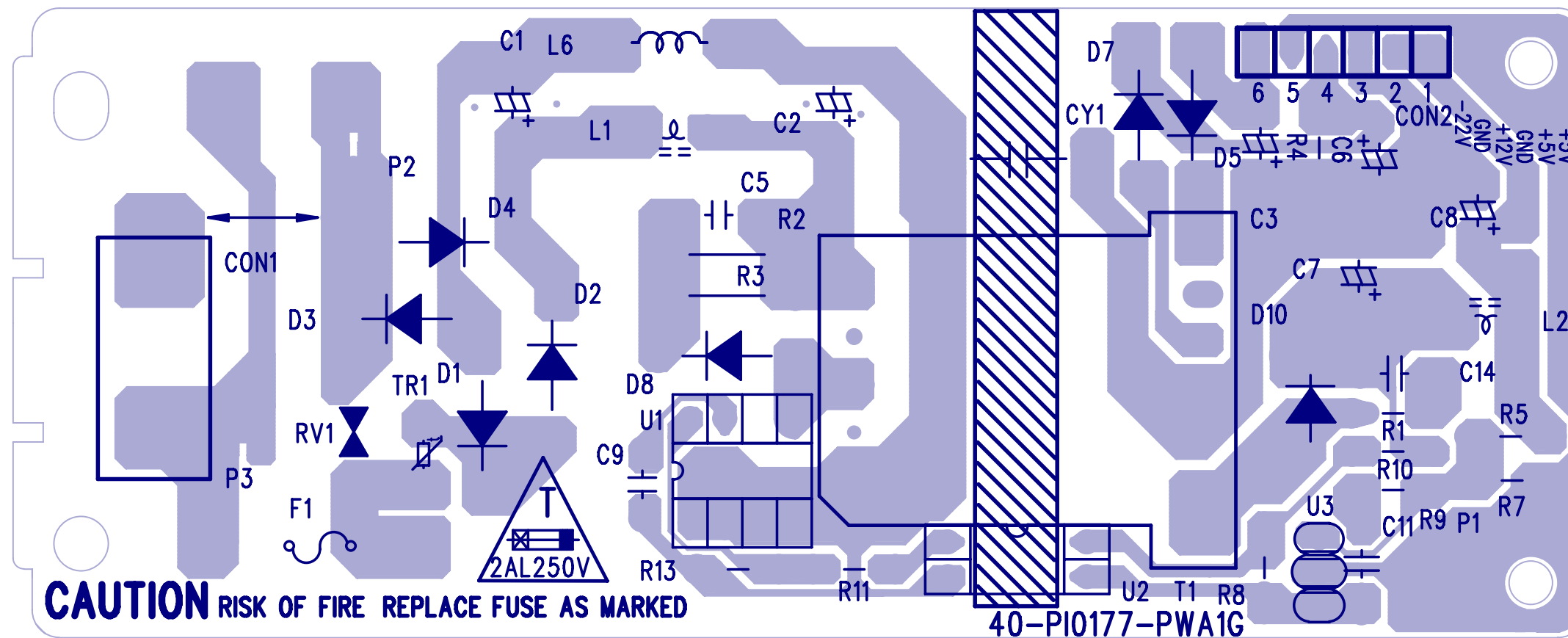

Power Board Print-layout for DVP3388K/96 (Bottom side):

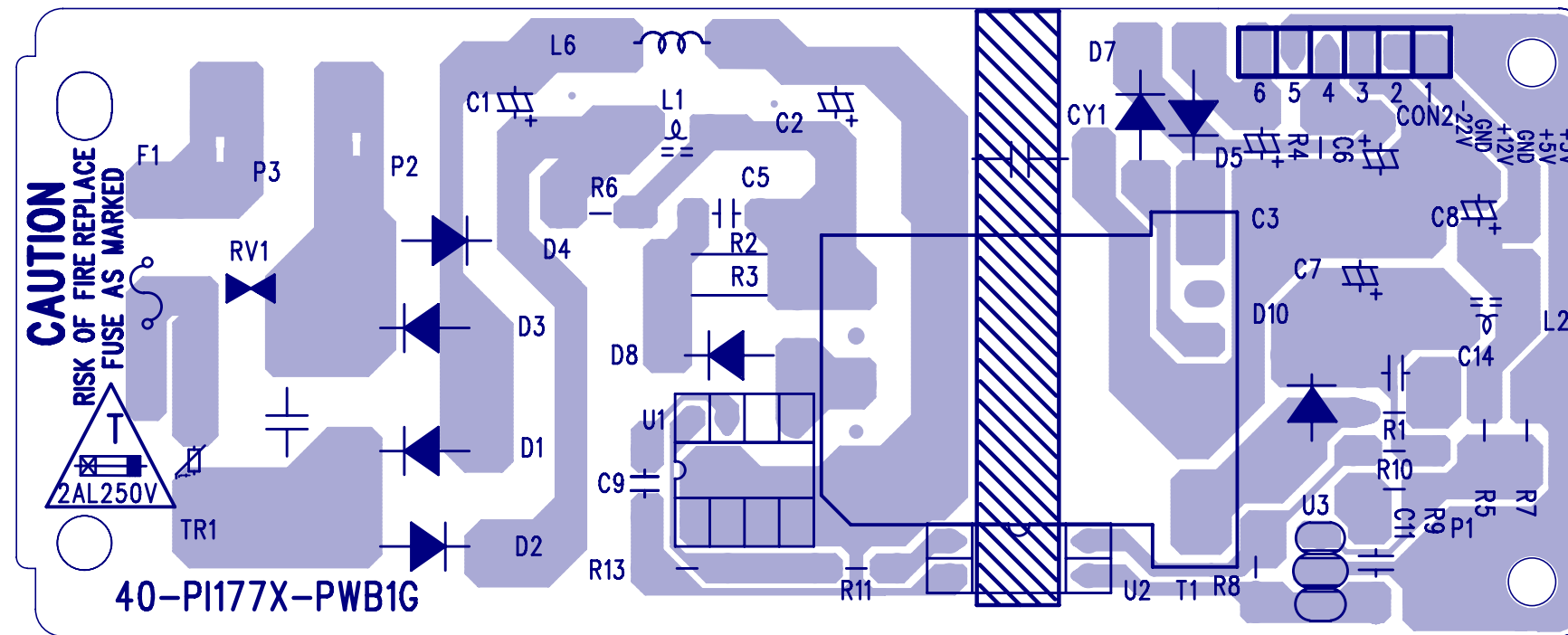

Main Board Print-layout (Top side):

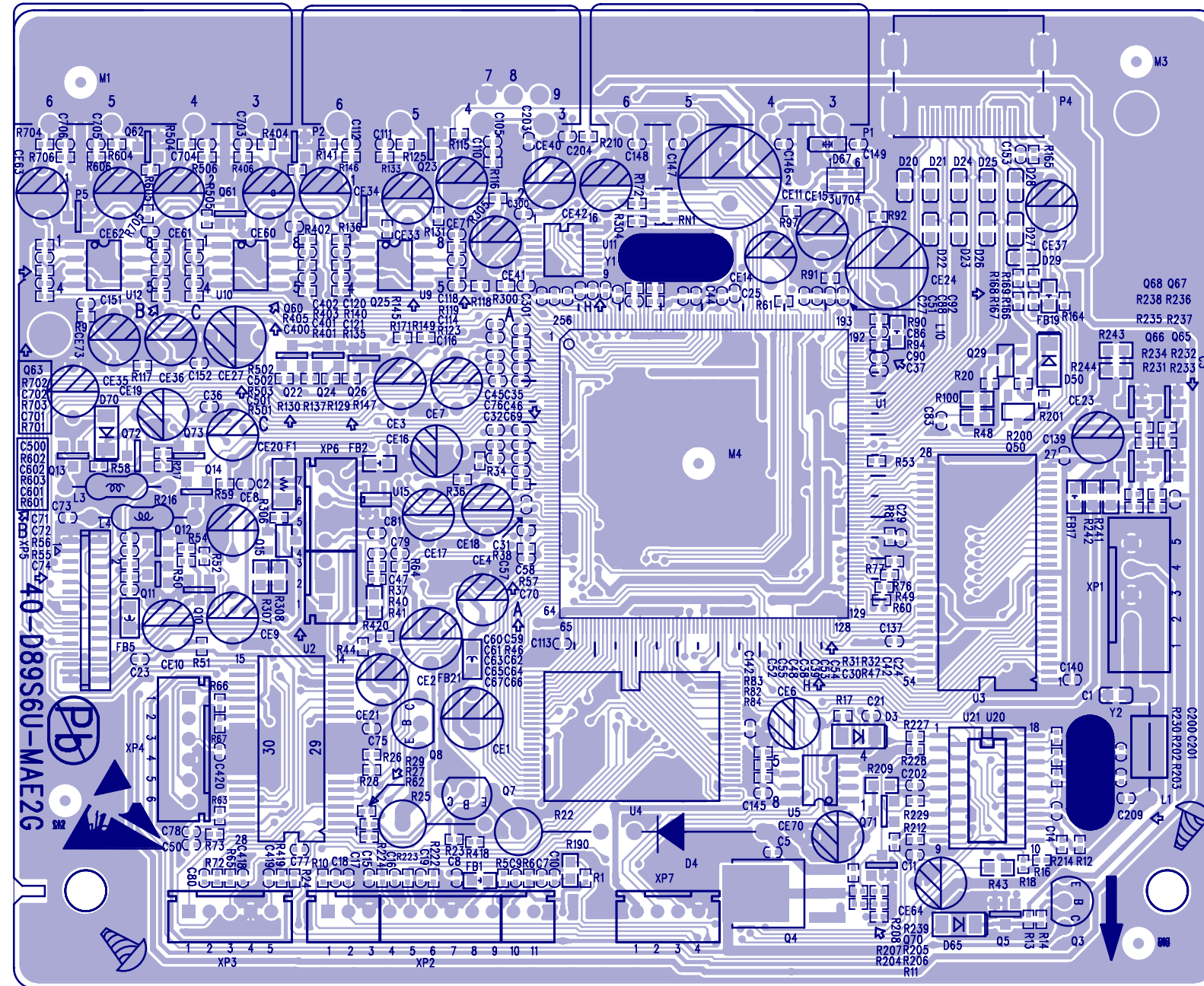

Main Board Print-layout (Bottom side):

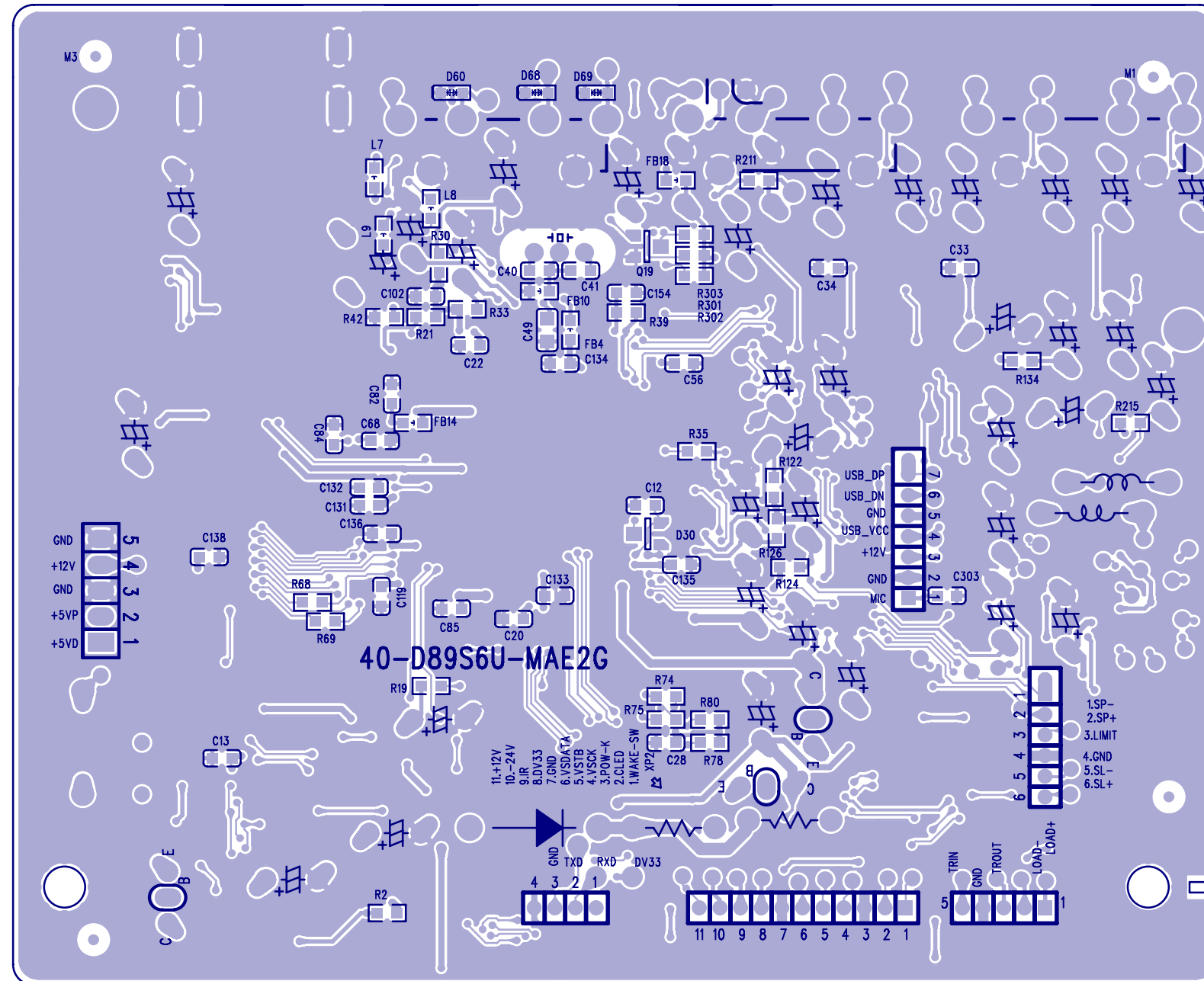

DVP3310K/93 Packing View:

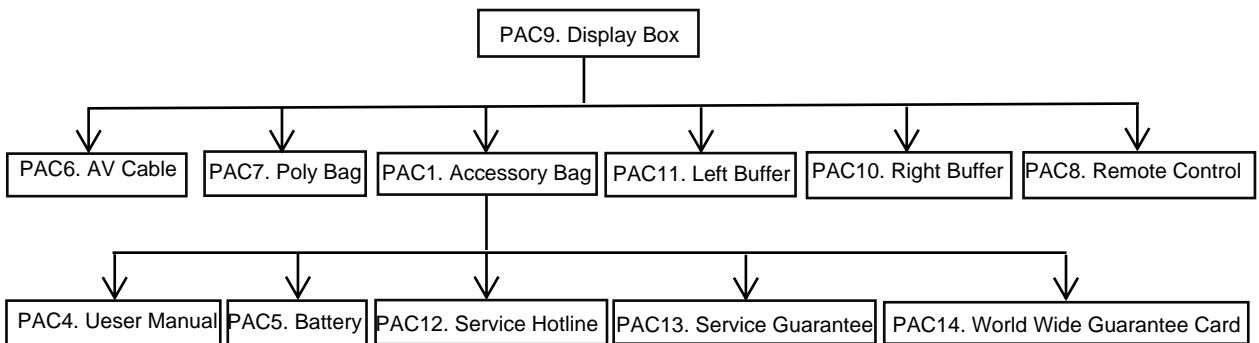
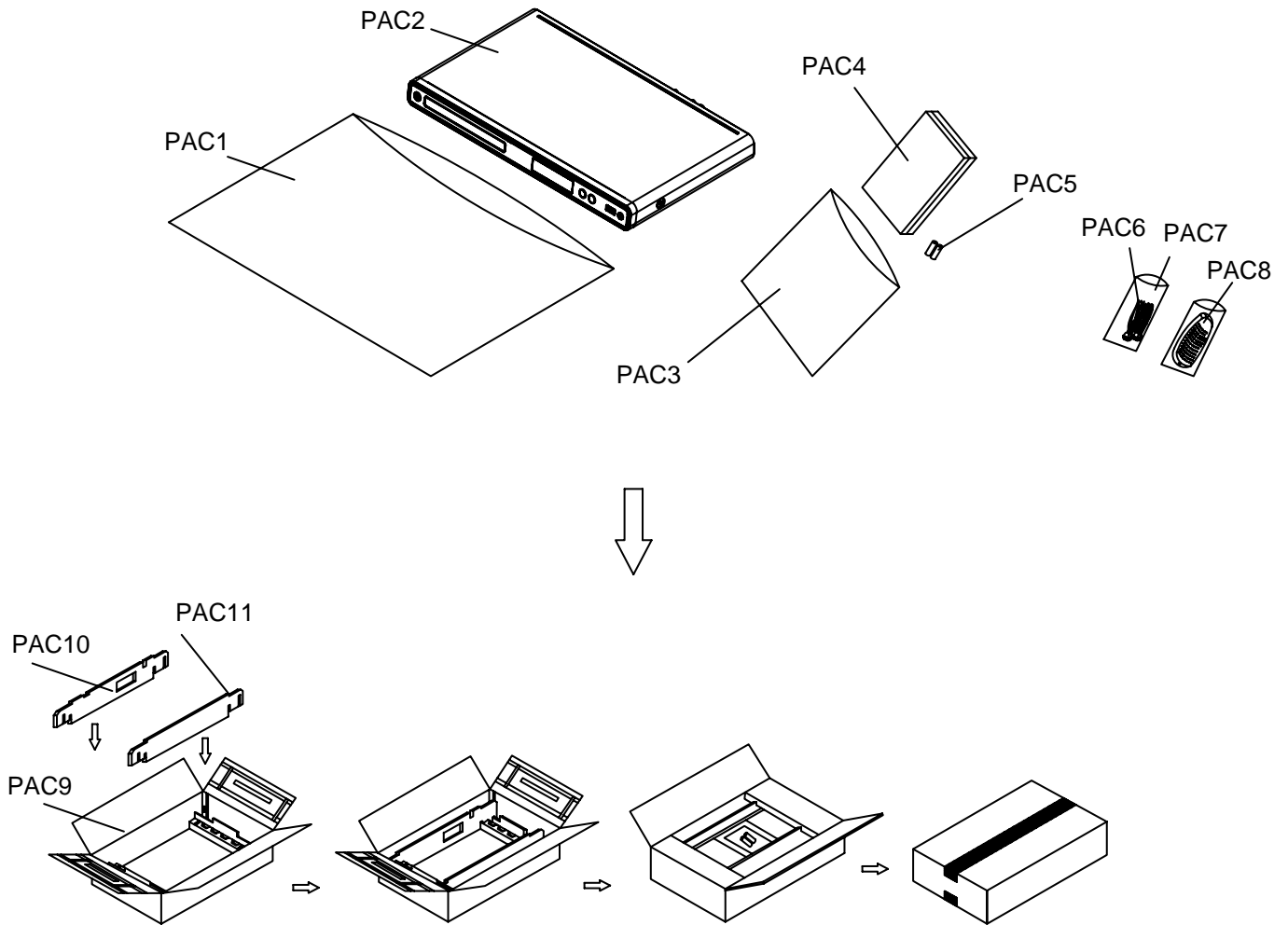

Exploded View for DVP3386K/93:

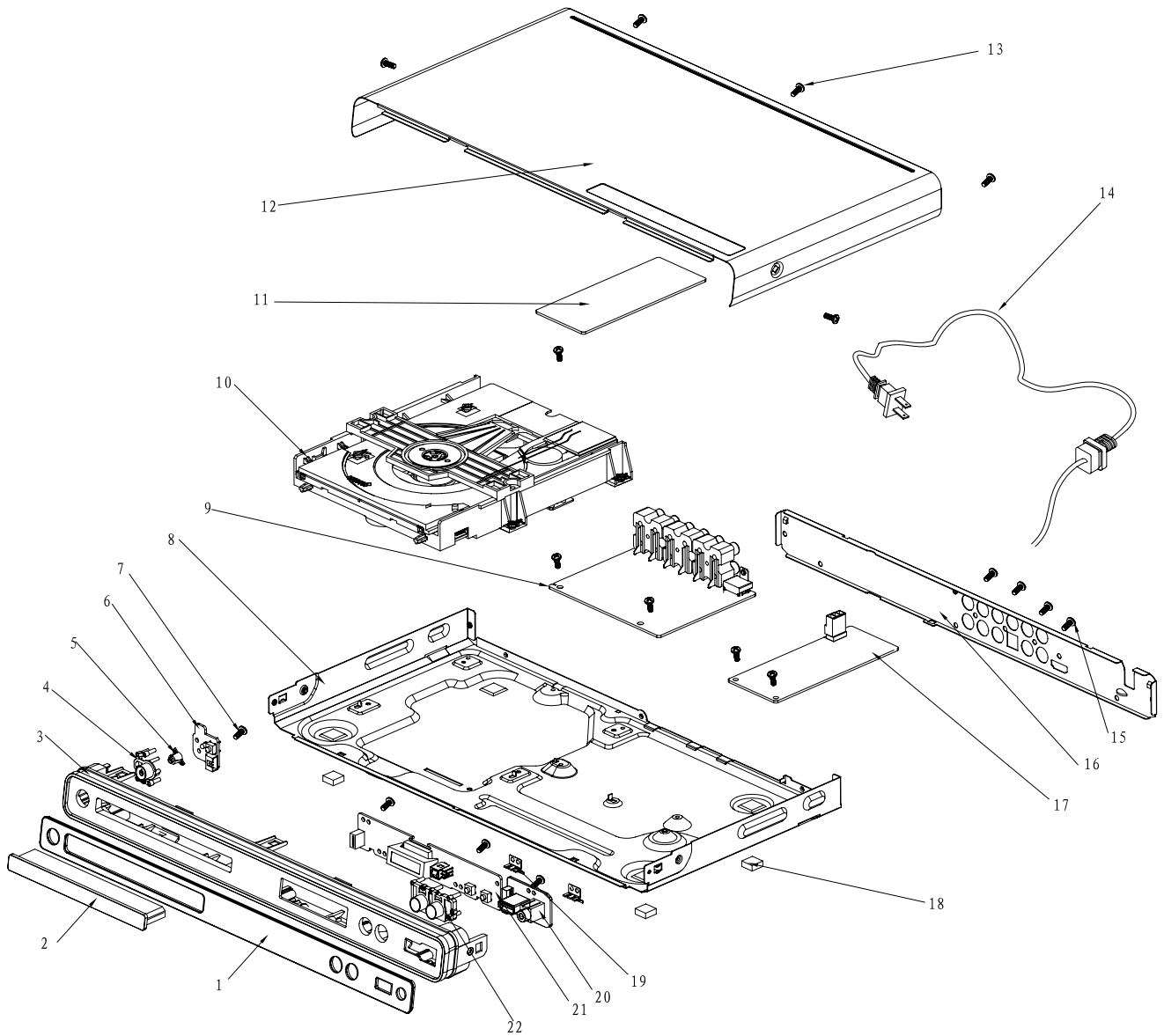

It's a general mechanical exploded view for DVP3386K/93, pls refer to the model set for detailed information.

Assy 1 component includes:1.3.4.5.22

Exploded View for DVP3388K/98 & DVP3388K/96:

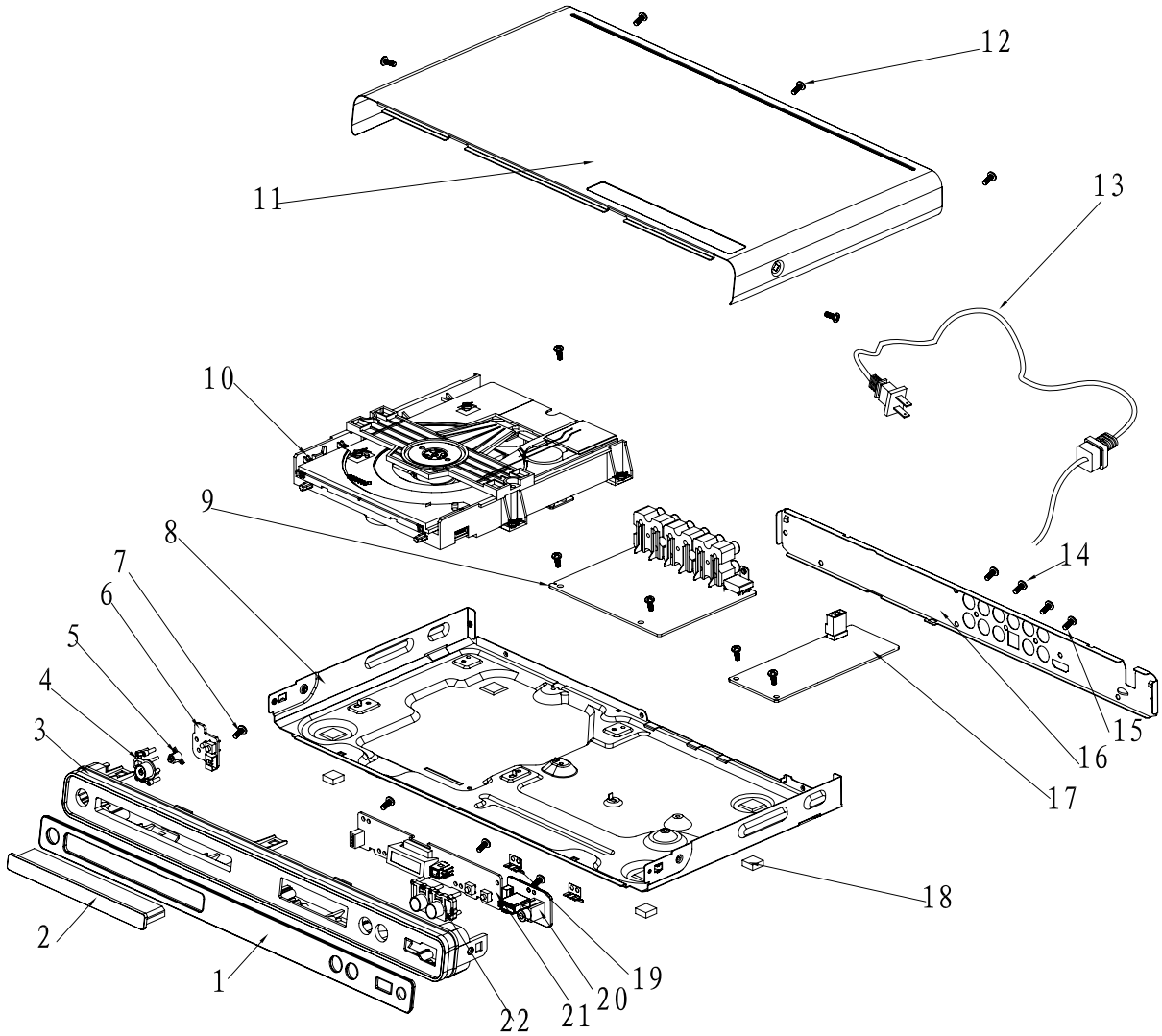

It's a general mechanical exploded view for DVP3386K/93, pls refer to the model set for detailed information.

Assy 1 component includes:1.3.4.5.22

Remark:power cord for DVP3388K/98 is detachable.

DVP3386K/93 SERVICE PARTLIST

ELECTRICAL PARTLIST

No	12NC No.	Description	Q'ty
9	996510022492	ASSY-MAIN BD	1
▲ 17	996510022409	ASSY-PW BD	1
20	996510022482	ASSY-KU BD	1
21	996510022477	ASSY-FB BD	1
6	996510020934	ASSY-SW BD	1
10	996510021457	LOADER	1
OPU	996510021449	SANYO LOADER (DV38)	1

ASSY-MAIN BD COMPONENT PARTLIST

NO	12NC NO.	Description	Q'ty
D30	996510009668	BAT54C	1
D50	996510009667	SMD. SWITCHING DIODE LL4148	1
D70	996510009667	SMD. SWITCHING DIODE LL4148	1
L3	996500014082	COIL CHOKE 10UH +/-10%	1
L4	996500014082	COIL CHOKE 10UH +/-10%	1
Q10	996510009669	SMD.TRANSISTOR MMBT3904LT1 NPN	1
Q11	996510009769	N Channel MOSFET 2SK3108	1
Q12	996510009769	N Channel MOSFET 2SK3108	1
Q13	996510009670	TRANSISTOR SMT 3CG9012M	1
Q14	996510009670	TRANSISTOR SMT 3CG9012M	1
Q15	996510010949	MOSFET AO3402	1
Q19	996510009669	SMD.TRANSISTOR MMBT3904LT1 NPN	1
Q22	996510009670	TRANSISTOR SMT 3CG9012M	1
Q23	996510009669	SMD.TRANSISTOR MMBT3904LT1 NPN	1
Q24	996510009670	TRANSISTOR SMT 3CG9012M	1
Q25	996510009669	SMD.TRANSISTOR MMBT3904LT1 NPN	1
Q26	996510009669	SMD.TRANSISTOR MMBT3904LT1 NPN	1
Q29	996510010922	ASM3402M/TR-LF SOT-23	1
Q3	996510009671	PNP TRANSISTOR	1
Q4	996510022478	MOS AOD480	1
Q5	996510009669	SMD.TRANSISTOR MMBT3904LT1 NPN	1
Q50	996510010949	MOSFET AO3402	1
Q60	996510009669	SMD.TRANSISTOR MMBT3904LT1 NPN	1
Q61	996510009669	SMD.TRANSISTOR MMBT3904LT1 NPN	1
Q62	996510009669	SMD.TRANSISTOR MMBT3904LT1 NPN	1
Q63	996510009669	SMD.TRANSISTOR MMBT3904LT1 NPN	1
Q65	996510009669	SMD.TRANSISTOR MMBT3904LT1 NPN	1
Q66	996510009669	SMD.TRANSISTOR MMBT3904LT1 NPN	1
Q67	996510009669	SMD.TRANSISTOR MMBT3904LT1 NPN	1
Q68	996510009669	SMD.TRANSISTOR MMBT3904LT1 NPN	1
Q7	996510009671	PNP TRANSISTOR	1
Q70	996510009669	SMD.TRANSISTOR MMBT3904LT1 NPN	1
Q71	996510009669	SMD.TRANSISTOR MMBT3904LT1 NPN	1
Q72	996510009670	TRANSISTOR SMT 3CG9012M	1
Q73	996510009670	TRANSISTOR SMT 3CG9012M	1
Q8	996510009671	PNP TRANSISTOR	1
U1	996510022481	IC MT1389FXE/SN	1
U10	996510010924	Dual operational amplifier	1
U11	996510012674	IC AK5358A	1
U12	996510010924	Dual operational amplifier	1
U15	996510013349	HDMI USB ESD PYOTECTION IC	1
U2	996510011055	IC CD5888CB	1
U20	996510022487	Holtek HT48R06A-1 MCU	1
U3	996510021455	64M SDRAM -6NS TSP54	1
U4	996510022486	16M Flash	1
U5	996510013348	2-WIRE SERIAL EEPROM 16K	1
U70	996510021013	IC PESD5VL4UG	1
U9	996510010924	Dual operational amplifier	1
Y1	996510009675	27MCL20PF	1
Y2	996510022484	CERAMIC RESONATOR	1

ASSY-KU BD COMPONENT PARTLIST

NO	12NC NO.	Description	Q'ty
U200	996500032494	IC AS4558M	1

ASSY-PW BD COMPONENT PARTLIST

NO	12NC NO.	Description	Q'ty
D1	996510011047	DIODE IN4007	1
D10	996500027866	DIODE SR360 3A/60V	1
D2	996510011047	DIODE IN4007	1
D3	996510011047	DIODE IN4007	1
D4	996510011047	DIODE IN4007	1
D7	996500014043	DIODE FR102 (FAST RECOVERY)	1
D8	996510011047	DIODE IN4007	1
L1	996510009942	COIL WIDTH	1
L2	996500032509	COIL SL0811-6R8K2R4	1
▲ T1	996510010954	TRANSFORMER CONV	1
U1	996510012685	IC TNY177PN	1
U2	996500027867	PHOTOCOUPLER PS2561L1-1-V(WF)	1
U3	996500014609	IC AM431LP	1

ASSY-FB BD COMPONENT PARTLIST

NO	12NC NO.	Description	Q'ty
LED1	996510020917	J2808AG	1
REM301	996510020925	HM338-12 RECEIVER MOD H=12MM	1
U301	996510009665	IC ET6202 SOP-2	1

MECHANICAL PARTLIST

No	12NC No.	Description	Q'ty
12	996510022475	TOP COVER	1
▲ 14	996510011203	POWER CORD	1
16	996510022502	BACK PANEL	1
18	996510006463	PAD	4
2	996510022485	FRONT DOOR	1
▲ 8	996510022483	BOTTOM PLATE	1
AVCABLE	996510001106	VIDEO CABLE 1500mm	1
Assy1	996510022488	ASS-Y - FRONT CABINET	1
CARD	996510019880	Worldwideguarantcard	1
CON2	996510022282	5PIN HS TJC3-5Y/SCN-5Y L=60MM	1
DBOX	996510022479	DISPLAY BOX	1
GUARANTEE	996500033761	SERVICE GUARANTEE	1
HOTLINE	996500042132	SERVICE HOT LINE	1
IFU	996510022476	USER MANUAL	1
LBUFFER	996510020937	LEFT CARD	1
QSG	996510022491	QSG	1
RBUFFER	996510021008	RIGHT CARD	1
RC	996510021964	REMOTE CONTROL	1
XP3	996510004063	CABLE PH-5Y/PH-5Y L=130MM	1
XP4	996510021448	6PIN HS	1
XP5	996510001168	24PIN HS	1
XP601	996510022489	7PIN USB+OK CBLESHIELD PITCH2	1
XS301	996510010111	Flat wire	1

SCREWS LIST:

No	12NC No.	Description	Q'ty
7	—	S/T SCREW B 2.6 X 8 BF	6
13	—	S/T SCREW B3 X 6 BF	9
15	—	S/T SCREW B 3 X 7 BF	5

DVP3388K/98 SERVICE PARTLIST

ELECTRICAL PARTLIST

No	12NC No.	Description	Q'ty
9	996510023879	ASSY-MAIN BD	1
▲ 17	996510020953	ASSY-PW BD	1
20	996510022482	ASSY-KU BD	1
21	996510022477	ASSY-FB BD	1
6	996510020934	ASSY-SW BD	1
10	996510021457	LOADER	1
OPU	996510021449	SANYO LOADER (DV38)	1

ASSY-MAIN BD COMPONENT PARTLIST

NO	12NC NO.	Description	Q'ty
D30	996510009668	BAT54C	1
D50	996510009667	SMD. SWITCHING DIODE LL4148	1
D65	996510009667	SMD. SWITCHING DIODE LL4148	1
D70	996510009667	SMD. SWITCHING DIODE LL4148	1
L3	996500014082	COIL CHOKE 10UH +/-10%	1
L4	996500014082	COIL CHOKE 10UH +/-10%	1
Q10	996510009669	SMD.TRANSISTOR MMBT3904LT1 NPN	1
Q11	996510009769	N Channel MOSFET 2SK3108	1
Q12	996510009769	N Channel MOSFET 2SK3108	1
Q13	996510009670	TRANSISTOR SMT 3CG9012M	1
Q14	996510009670	TRANSISTOR SMT 3CG9012M	1
Q15	996510022279	PNP TRANSISTOR SOT-23PBSS5320T	1
Q19	996510009669	SMD.TRANSISTOR MMBT3904LT1 NPN	1
Q22	996510009670	TRANSISTOR SMT 3CG9012M	1
Q23	996510009669	SMD.TRANSISTOR MMBT3904LT1 NPN	1
Q24	996510009670	TRANSISTOR SMT 3CG9012M	1
Q25	996510009669	SMD.TRANSISTOR MMBT3904LT1 NPN	1
Q26	996510009669	SMD.TRANSISTOR MMBT3904LT1 NPN	1
Q29	996510010922	ASM3402M/TR-LF SOT-23	1
Q3	996510009671	PNP TRANSISTOR	1
Q4	996510022478	MOS AOD480	1
Q5	996510009669	SMD.TRANSISTOR MMBT3904LT1 NPN	1
Q50	996510010949	MOSFET AO3402	1
Q60	996510009669	SMD.TRANSISTOR MMBT3904LT1 NPN	1
Q61	996510009669	SMD.TRANSISTOR MMBT3904LT1 NPN	1
Q62	996510009669	SMD.TRANSISTOR MMBT3904LT1 NPN	1
Q63	996510009669	SMD.TRANSISTOR MMBT3904LT1 NPN	1
Q65	996510009669	SMD.TRANSISTOR MMBT3904LT1 NPN	1
Q66	996510009669	SMD.TRANSISTOR MMBT3904LT1 NPN	1
Q67	996510009669	SMD.TRANSISTOR MMBT3904LT1 NPN	1
Q68	996510009669	SMD.TRANSISTOR MMBT3904LT1 NPN	1
Q7	996510009671	PNP TRANSISTOR	1
Q70	996510009669	SMD.TRANSISTOR MMBT3904LT1 NPN	1
Q71	996510009669	SMD.TRANSISTOR MMBT3904LT1 NPN	1
Q72	996510009670	TRANSISTOR SMT 3CG9012M	1
Q73	996510009670	TRANSISTOR SMT 3CG9012M	1
Q8	996510009671	PNP TRANSISTOR	1
U1	996510022481	IC MT1389FXE/SN	1
U10	996510010924	Dual operational amplifier	1
U11	996510012674	IC AK5358A	1
U12	996510010924	Dual operational amplifier	1
U15	996510013349	HDMI USB ESD PYOTECTION IC	1
U2	996510011055	IC CD5888CB	1
U20	996510022487	Holtek HT48R06A-1 MCU	1
U3	996510013315	64M SDRAM HY57V641620FTP-7-C	1
U4	996510013452	16M Flash	1
U5	996510013348	2-WIRE SERIAL EEPROM 16K	1
U70	996510021013	IC PESD5VL4UG	1
U9	996510010924	Dual operational amplifier	1
Y1	996510009675	27MCL20PF	1
Y2	996510022484	CERAMIC RESONATOR	1

ASSY-KU BD COMPONENT PARTLIST

NO	12NC NO.	Description	Q'ty
U200	996500032494	IC AS4558M	1

ASSY-PW BD COMPONENT PARTLIST

NO	12NC NO.	Description	Q'ty
D1	996510011047	DIODE IN4007	1
D10	996500027866	DIODE SR360 3A/60V	1
D2	996510011047	DIODE IN4007	1
D3	996510011047	DIODE IN4007	1
D4	996510011047	DIODE IN4007	1
D7	996500014043	DIODE FR102 (FAST RECOVERY)	1
D8	996510011047	DIODE IN4007	1
L1	996510009942	COIL WIDTH	1
L2	996500032509	COIL SL0811-6R8K2R4	1
▲ T1	996510010954	TRANSFORMER CONV	1
U1	996510012685	IC TNY177PN	1
U2	996500027867	PHOTOCOUPLER PS2561L1-1-V(WF)	1
U3	996500014609	IC AM431LP	1

ASSY-FB BD COMPONENT PARTLIST

NO	12NC NO.	Description	Q'ty
LED1	996510020917	J2808AG	1
REM301	996510020925	HM338-12 RECEIVER MOD H=12MM	1
U301	996510009665	IC ET6202 SOP-2	1

MECHANICAL PARTLIST

No	12NC No.	Description	Q'ty
11	996510022475	TOP COVER	1
▲ 13	996510001537	DETACHABLE POWER CORD	1
16	996510023885	BACK PANEL	1
18	996510006463	PAD	4
2	996510023881	FRONT DOOR	1
▲ 8	996510022483	BOTTOM PLATE	1
AVCABLE	996510001106	VIDEO CABLE 1500mm	1
Assy1	996510022488	ASS-Y - FRONT CABINET	1
CON2	996510011060	5PINBLE TJC3-5Y/SCN-5P L=70MM	1
RC	996510020927	REMOTE CONTROL	1
XP3	996510004063	CABLE PH-5Y/PH-5Y L=130MM	1
XP4	996510021448	6PIN HS	1
XP5	996510001168	24PIN HS	1
XP601	996510022489	7PIN USB+OK CBLESHIELD PITCH2	1
XS301	996510010111	Flat wire	1

SCREWS LIST:

No	12NC No.	Description	Q'ty
7	—	S/T SCREW B 2.6 X 8 BF	6
12	—	S/T SCREW B3 X 6 BF	9
14	—	S/T SCREW B 3 X 7 BF	5

DVP3388K/96 SERVICE PARTLIST

ELECTRICAL PARTLIST

No	12NC No.	Description	Q'ty
9	996510023883	ASSY-MAIN BD	1
▲ 17	996510023882	ASSY-PW BD	1
20	996510022482	ASSY-KU BD	1
21	996510022477	ASSY-FB BD	1
6	996510020934	ASSY-SW BD	1
10	996510021457	LOADER	1
OPU	996510021449	SANYO LOADER (DV38)	1

ASSY-MAIN BD COMPONENT PARTLIST

NO	12NC NO.	Description	Q'ty
D30	996510009668	BAT54C	1
D50	996510009667	SMD. SWITCHING DIODE LL4148	1
D65	996510009667	SMD. SWITCHING DIODE LL4148	1
D70	996510009667	SMD. SWITCHING DIODE LL4148	1
L3	996500014082	COIL CHOKE 10UH +/-10%	1
L4	996500014082	COIL CHOKE 10UH +/-10%	1
Q10	996510009669	SMD.TRANSISTOR MMBT3904LT1 NPN	1
Q11	996510009769	N Channel MOSFET 2SK3108	1
Q12	996510009769	N Channel MOSFET 2SK3108	1
Q13	996510009670	TRANSISTOR SMT 3CG9012M	1
Q14	996510009670	TRANSISTOR SMT 3CG9012M	1
Q15	996510022279	PNP TRANSISTOR SOT-23PBSS5320T	1
Q19	996510009669	SMD.TRANSISTOR MMBT3904LT1 NPN	1
Q22	996510009670	TRANSISTOR SMT 3CG9012M	1
Q23	996510009669	SMD.TRANSISTOR MMBT3904LT1 NPN	1
Q24	996510009670	TRANSISTOR SMT 3CG9012M	1
Q25	996510009669	SMD.TRANSISTOR MMBT3904LT1 NPN	1
Q26	996510009669	SMD.TRANSISTOR MMBT3904LT1 NPN	1
Q29	996510010922	ASM3402M/TR-LF SOT-23	1
Q3	996510009671	PNP TRANSISTOR	1
Q4	996510022478	MOS AOD480	1
Q5	996510009669	SMD.TRANSISTOR MMBT3904LT1 NPN	1
Q50	996510010949	MOSFET AO3402	1
Q60	996510009669	SMD.TRANSISTOR MMBT3904LT1 NPN	1
Q61	996510009669	SMD.TRANSISTOR MMBT3904LT1 NPN	1
Q62	996510009669	SMD.TRANSISTOR MMBT3904LT1 NPN	1
Q63	996510009669	SMD.TRANSISTOR MMBT3904LT1 NPN	1
Q65	996510009669	SMD.TRANSISTOR MMBT3904LT1 NPN	1
Q66	996510009669	SMD.TRANSISTOR MMBT3904LT1 NPN	1
Q67	996510009669	SMD.TRANSISTOR MMBT3904LT1 NPN	1
Q68	996510009669	SMD.TRANSISTOR MMBT3904LT1 NPN	1
Q7	996510009671	PNP TRANSISTOR	1
Q70	996510009669	SMD.TRANSISTOR MMBT3904LT1 NPN	1
Q71	996510009669	SMD.TRANSISTOR MMBT3904LT1 NPN	1
Q72	996510009670	TRANSISTOR SMT 3CG9012M	1
Q73	996510009670	TRANSISTOR SMT 3CG9012M	1
Q8	996510009671	PNP TRANSISTOR	1
U1	996510022481	IC MT1389FXE/SN	1
U10	996510010924	Dual operational amplifier	1
U11	996510012674	IC AK5358A	1
U12	996510010924	Dual operational amplifier	1
U15	996510013349	HDMI USB ESD PYOTECTION IC	1
U2	996510009674	IC AM5888IC	1
U20	996510022487	Holtek HT48R06A-1 MCU	1
U3	996510020959	IC EM638165TS-6G	1
U4	996510013351	16M FLASH	1
U5	996510013348	2-WIRE SERIAL EEPROM 16K	1
U70	996510021013	IC PESD5VL4UG	1
U9	996510010924	Dual operational amplifier	1
Y1	996510009675	27MCL20PF	1
Y2	996510022484	CERAMIC RESONATOR	1

ASSY-KU BD COMPONENT PARTLIST

NO	12NC NO.	Description	Q'ty
U200	996500032494	IC AS4558M	1

ASSY-PW BD COMPONENT PARTLIST

NO	12NC NO.	Description	Q'ty
D1	996510011047	DIODE IN4007	1
D10	996500027866	DIODE SR360 3A/60V	1
D2	996510011047	DIODE IN4007	1
D3	996510011047	DIODE IN4007	1
D4	996510011047	DIODE IN4007	1
D7	996500014043	DIODE FR102 (FAST RECOVERY)	1
D8	996510011047	DIODE IN4007	1
L1	996510009942	COIL WIDTH	1
L2	996500032509	COIL SL0811-6R8K2R4	1
▲ T1	996510012665	TRANSFORMER CONV.	1
U1	996510012685	IC TNY177PN	1
U2	996500027867	PHOTOCOUPLER PS2561L1-1-V(WF)	1
U3	996500014609	IC AM431LP	1

ASSY-FB BD COMPONENT PARTLIST

NO	12NC NO.	Description	Q'ty
LED1	996510020917	J2808AG	1
REM301	996510020925	HM338-12 RECEIVER MOD H=12MM	1
U301	996510009665	IC ET6202 SOP-2	1

MECHANICAL PARTLIST

No	12NC No.	Description	Q'ty
11	996510022475	TOP COVER	1
▲ 13	996510021478	POWER CORD	1
16	996510023886	BACK PANEL	1
18	996510006463	PAD	4
2	996510023881	FRONT DOOR	1
▲ 8	996510022483	BOTTOM PLATE	1
AVCABLE	996510001106	VIDEO CABLE 1500mm	1
Assy1	996510022488	ASS-Y - FRONT CABINET	1
CON2	996510022282	5PIN HS TJC3-5Y/SCN-5Y L=60MM	1
RC	996510020927	REMOTE CONTROL	1
XP3	996510004063	CABLE PH-5Y/PH-5Y L=130MM	1
XP4	996510021448	6PIN HS	1
XP5	996510001168	24PIN HS	1
XP601	996510022489	7PIN USB+OK CBLESHIELD PITCH2	1
XS301	996510010111	Flat wire	1

SCREWS LIST:

No	12NC No.	Description	Q'ty
7	—	S/T SCREW B 2.6 X 8 BF	6
12	—	S/T SCREW B3 X 6 BF	9
14	—	S/T SCREW B 3 X 7 BF	5

REVISION LIST

Version 1.0

* Initial release for DVP3386K/93 & DVP3388K/98 & DVP3388K/96